

AVM 105S, 115S: Valve actuator with SAUTER Universal Technology (SUT)

How energy efficiency is improved

Automatic adaptation to valve, precision activation and high energy efficiency with minimal operating noise

Features

- Activation of 2-way and 3-way valves of the VUN/BUN, VUD/BUD and VUE/BUE series
- For controllers with a switching (2- and 3-point) or continuous (0...10 V) output
- Stepping motor with SAUTER Universal Technology (SUT) electronic control unit and electronic, force-dependent cut-off
- Automatic recognition of applied control signal (continuous or switched)
- Coding switches for selecting characteristic and running time
- Type of characteristic (linear/equal-percentage) can be set on the actuator
- Automatic adaptation to valve stroke
- Maintenance-free gearbox
- Gear unit can be disengaged in order to position the valve by hand (hexagon key provided)
- Connection with valve spindle performed automatically after control voltage is applied
- Brass cap nut for fitting the valve
- Fitting vertically upright to horizontal, not suspended



AVM1*5SF***

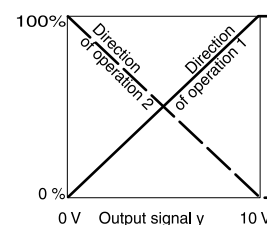

Technical data

Power supply		
	Power supply 24 V~	±20%, 50...60 Hz
	Power supply 24 V=	-10%...20%
Parameters		
	Actuator stroke ¹⁾	0...8 mm
	Response time	200 ms
Positioner	Control signal	0...10 V, R _i > 100 kΩ
	Positional feedback signal	0...10 V; load > 10 kΩ
	Starting point U ₀	0 or 10 V
	Control span ΔU	10 V
	Switching range X _{sh}	200 mV
Ambient conditions		
	Admissible ambient temperature	-10...55 °C
	Admissible ambient humidity	5...95% rh, no condensation
	Temperature of medium	Max. 100 °C
Construction		
	Weight	0.7 kg
	Housing	Lower section black, upper section yellow
	Housing material	Fire-retardant plastic
	Power cable	1.2 m, 5 × 0.75 mm ²
Standards and directives		
	Type of protection	IP54 (EN 60529), horizontal
	Protection class	III (IEC 60730)
CE conformity	EMC Directive 2014/30/EU	EN 61000-6-1, EN 61000-6-3, EN 61000-6-4

¹⁾ Stroke 10 mm for AVM115SF901



Overview of types

Type	Actuating power (N)	Voltage	Running time	Power consumption
AVM105SF132	250	24 V~/=	35/60/120 s	4.8 W, 8.5 VA
AVM115SF132	500	24 V~/=	60/120 s	4.9 W, 8.7 VA
AVM115SF901	500	24 V~/=	80/160 s	4.9 W, 8.7 VA

 *AVM105SF132, AVM115SF132: Equal-percentage characteristic, can be converted to linear*

 *AVM115SF901: For SAUTER Valveco VCL040 and VCL050, inverse scale, inverse connection*

Accessories

Type	Description
0313529001	Split-range unit for adjusting sequences, fitted in separate junction box
0372145001	Auxiliary change-over contacts, single
0372145002	Auxiliary change-over contacts, double
0372249001	Temperature adapter for AVM 321(S), media temperature > 100...130 °C
0372273001	Adapter for Siemens valve VVG/VXG 44, 48
0372286001	Potentiometer, 130 Ω
0372286002	Potentiometer, 1000 Ω
0372286003	Potentiometer, 5000 Ω
0372462001	CASE Drives: PC tool for configuring the drives by computer

 *Auxiliary change-over contacts: Infinitely variable 0...100%, admissible load 5(2) A, 24...230 V*

 *Potentiometers: Only one potentiometer or one set of auxiliary contacts can be fitted for each actuator*

Description of operation

Depending on the type of connection (see connection diagram), the actuator can be used as a continuous 0...10 V, 2-point (OPEN/CLOSE) or 3-point actuator (OPEN/STOP/CLOSE) with an intermediate position.

The running time of the actuator can be set with switches S1 and S2 (AVM 105 only S1) according to requirements. Switch S3 can be used to select the equal-percentage or linear characteristic. The AVM 105/115 is combined with valves that have an equal-percentage basic characteristic like the VUD, BUD, VUE and BUE valves. The AVM 115 can be mounted on a valve with a linear characteristic (e.g. VUE 050F200), but the position of the coding switch must be considered. With the AVM 105, no equal-percentage characteristic can be created for a valve with a linear characteristic.

The manual adjustment is performed by releasing the gear unit (slide switch beside the connection cable) and simultaneously turning it with the hex spanner on the top part of the actuator. 8 mm stroke achieved with 1½ turns.



Note

After manually moving the slide switch, put it back into its original position (engage gear unit).

Intended use

This product is only suitable for the purpose intended by the manufacturer, as described in the "Description of operation" section.

All related product regulations must also be adhered to. Changing or converting the product is not admissible.

Connection as 2-point actuator

This OPEN/CLOSE activation can be performed via 2 cables. The actuator is connected to the voltage via the blue and brown cables. The control passage of the valve is opened by connecting the voltage to the black cable. After this voltage is switched off, the actuator moves to the opposite end position and closes the valve.

The unused red and grey wires must not be connected or come into contact with other cables. We recommend that you insulate these.

Connection as 3-point control unit

When voltage is applied to the cable (brown or black), the valve is moved to any desired position. The coupling rod moves out and opens the valve when voltage is applied to the black cable. It moves in and closes the valve when the electrical circuit is closed via the blue and brown cables.

In the end positions (limit stop in valve or maximum stroke reached) or in the case of an overload, the electronic motor cut-off is activated (no limit switches). Direction of the stroke changed by transposing

the connections (BN/BK). The unused red and grey wires must not be connected or come into contact with other cables. We recommend that you insulate these.

Connection for control voltage 0...10 V

The built-in positioner controls the actuator depending on controller's output signal y .

Direction of operation 1 (mains power supply on brown cable):

When the positioning signal is increasing, the coupling rod moves out and opens the valve (control passage).

Direction of operation 2 (mains power supply on black cable):

When the positioning signal is increasing, the coupling rod moves in and closes the valve (control passage).

The starting point and the control span are fixed. A split-range unit (accessory) is available for setting partial ranges.

After a manual adjustment or a power failure of more than at least 5 min, the actuator automatically readjusts itself, always with a running time of:

AVM 105: 35 s

AVM 115: 60 s

After the power supply is connected, the stepping motor moves to the lower limit stop, makes the connection with the valve spindle, moves to the upper limit stop and thus defines the closing position.

After this, every stroke between 0 and 8 mm can be achieved, depending on the control voltage.

Thanks to the electronics, no steps can be lost, and the actuator does not require periodic re-adjustment. It is possible to operate multiple actuators of the same type in parallel. The feedback signal $y_0 = 0...10$ V corresponds to the effective stroke of 0 to 8 mm.

When control signal 0...10 V is interrupted and direction of operation 1 is connected, the valve is closed completely (0% position).

The coding switch can be used to select the characteristic of the valve. Characteristics can only be generated when the actuator is used as a continuous actuator. The running times can be selected with additional switches. These can be used regardless of whether the 2-point, 3-point or continuous function is selected.

Additional technical data

The upper section of the housing with the cover, indicator knob and cover knob contains the stepping motor and the SUT electronics. The lower section of the housing contains the maintenance-free gear unit.

Auxiliary change-over contacts:

- Switch rating max. 230 V VAC, current min. 20 mA at 20 V
- Switch rating max. 4...30 V VDC, current 1...100 mA

Power consumption

Type	Running time [s]	Status	Active power P [W]	Apparent power S [VA]
AVM105F132	35	Operation	2.45	4.75
		Standstill	0.35	0.8
	60	Operation	4.8	8.5
		Standstill	0.35	0.8
AVM115F132	120	Operation	2.2	4.25
		Standstill	0.35	0.8
	60	Operation	4.9	8.7
		Standstill	0.35	0.75
120	Operation	2.25	4.3	
	Standstill	0.35	0.75	

Coding switch for selecting running time

AVM 105S

Run time per mm	Switch coding	Run time for 8 mm stroke																														
4,375 s	<table border="0"> <tr> <td>1</td><td>2</td><td>3</td><td>4</td><td></td> </tr> <tr> <td></td><td></td><td></td><td></td><td>On</td> </tr> <tr> <td></td><td></td><td></td><td></td><td>Off</td> </tr> </table>	1	2	3	4						On					Off	35 s ± 1															
1	2	3	4																													
				On																												
				Off																												
7,5 s	<table border="0"> <tr> <td>1</td><td>2</td><td>3</td><td>4</td><td></td> </tr> <tr> <td></td><td></td><td></td><td></td><td>On</td> </tr> <tr> <td></td><td></td><td></td><td></td><td>Off</td> </tr> </table>	1	2	3	4						On					Off	60 s ± 2															
1	2	3	4																													
				On																												
				Off																												
15 s	<table border="0"> <tr> <td>1</td><td>2</td><td>3</td><td>4</td><td></td> </tr> <tr> <td></td><td></td><td></td><td></td><td>On </td> </tr> <tr> <td></td><td></td><td></td><td></td><td>Off</td> </tr> <tr> <td colspan="5"> </td> </tr> <tr> <td></td><td></td><td></td><td></td><td>On</td> </tr> <tr> <td></td><td></td><td></td><td></td><td>Off</td> </tr> </table>	1	2	3	4						On					Off										On					Off	120 s ± 4
1	2	3	4																													
				On																												
				Off																												
				On																												
				Off																												
= factory setting																																

B10702a

AVM 115S

Run time per mm	Switch coding	Run time for 8 mm stroke												
7,5 s	<table border="0"> <tr> <td>1</td><td>2</td><td>3</td><td></td> </tr> <tr> <td></td><td></td><td></td><td>On</td> </tr> <tr> <td></td><td></td><td></td><td>Off</td> </tr> </table>	1	2	3					On				Off	60 s ± 2
1	2	3												
			On											
			Off											
15 s	<table border="0"> <tr> <td>1</td><td>2</td><td>3</td><td></td> </tr> <tr> <td></td><td></td><td></td><td>On </td> </tr> <tr> <td></td><td></td><td></td><td>Off </td> </tr> </table>	1	2	3					On				Off	120 s ± 4
1	2	3												
			On											
			Off											
= factory setting														

B10703







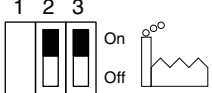
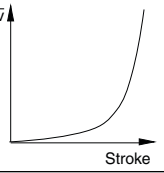
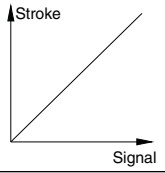
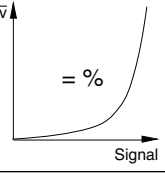

Coding switch for selecting characteristic

AVM 105S

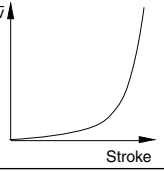
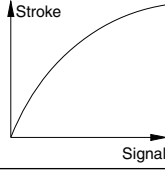
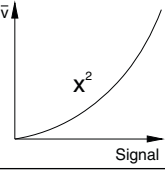
Desired character. curve	Switch coding	Characteristic curve for valve	Characteristic curve for drive	Effective on valve
Equal percentage				
Linear				
Linear				
	= factory setting			

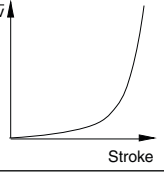
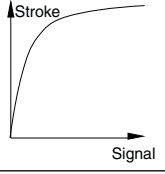
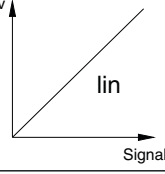
B10704

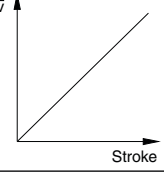
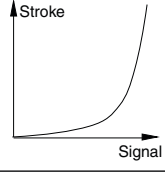
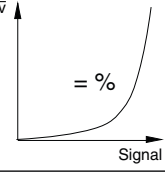
AVM 115S

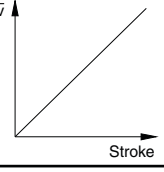
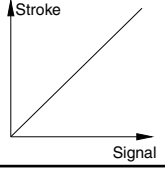
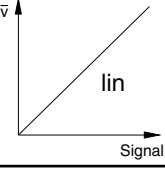
Desired character. curve	Switch coding	Characteristic curve for valve	Characteristic curve for drive	Effective on valve
Equal percentage				
Quadratic				
Linear				
Equal percentage				
Linear				

 = factory setting

B10705

Split-range unit, accessory 0361529 001

Starting point U_0 and control span ΔU can be set with the potentiometer. In this way, several control units can be operated in sequence or cascade by the control signal of the controller. The input signal (partial range) is amplified into an output signal of 0...10V. This accessory cannot be built into the actuator but must be externally housed in an electrical junction box.

CASE Drives PC Tool, accessory 0372462 001

CASE Drives allows you to set and read the actuator parameters on site. The connection is via a serial port on the PC (laptop) and a socket on the actuator. The set consists of: The software including installation and operating manual, fitting instructions, connection plug, cable (1.2 m long) and interface converter for the PC. The application is designed for commissioning and service engineers as well as experienced operators.

The last setting has priority, whether made with the coding switch or CASE Drives. When a change-over is made with the coding switch, this setting is active. In order that the settings made with CASE Drives cannot be overwritten, the coding switch must be removed before the setting with CASE Drives (delivery includes special tool).

Engineering and fitting notes

Condensate, dripping water, etc. must be prevented from entering the actuator along the valve spindle.

When connecting the electricity supply, ensure that the cross-section of the power cable is adapted to the power output and the length. However, in all cases we recommend a minimum cross-section of 0.75 mm².

The actuator / valve is mounted by attaching and tightening the cap nut without any additional adjustment. The coupling of the valve spindle with the actuator spindle is performed automatically, either by using the manual adjustment or by connecting the voltage. When dismantling, first unlock the actuator and valve spindles, then loosen the cap nut. The device is delivered ex works in the middle position.

The concept of stepping motor and electronics enables parallel operation of multiple actuators of the same SUT type.

The maximum accessory equipment for an actuator is 1 auxiliary contact (single or double).

The coding switches are accessible via an opening with a black cover in the housing lid.

The auxiliary contact accessory is screwed onto the top cover of the actuator. To be able to make the mechanical connection, you first have to remove the indicator knob. A new indicator can be seen on the cover of the accessory.

Note! The housing must not be opened.

Outdoor installation

If installed outside of buildings, the devices must be additionally protected from the weather.

Disposal

When disposing of the product, observe the currently applicable local laws.

More information on materials can be found in the Declaration on materials and the environment for this product.

Connection diagram

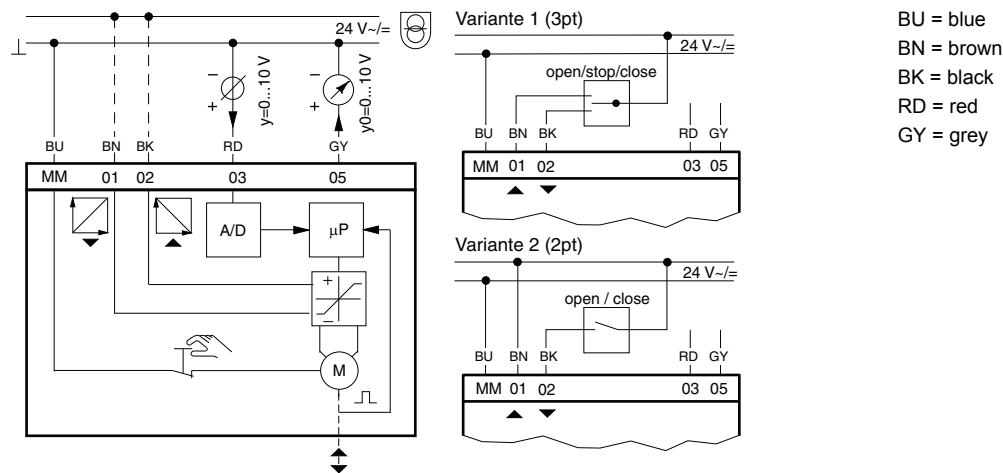

Accessories

<p>372145 001</p>	<p>372145 002</p> <p>RD = red BN = brown BK = black GN = green GY = grey VT = violet</p>
<p>0313529</p> <p>1 2 3 33 1 2a 3u MM 01/02/LS 03 AVM ...S AVF ...S ASF ...S AXM ...S ASM ...S AKM ...S</p>	

Dimension drawing

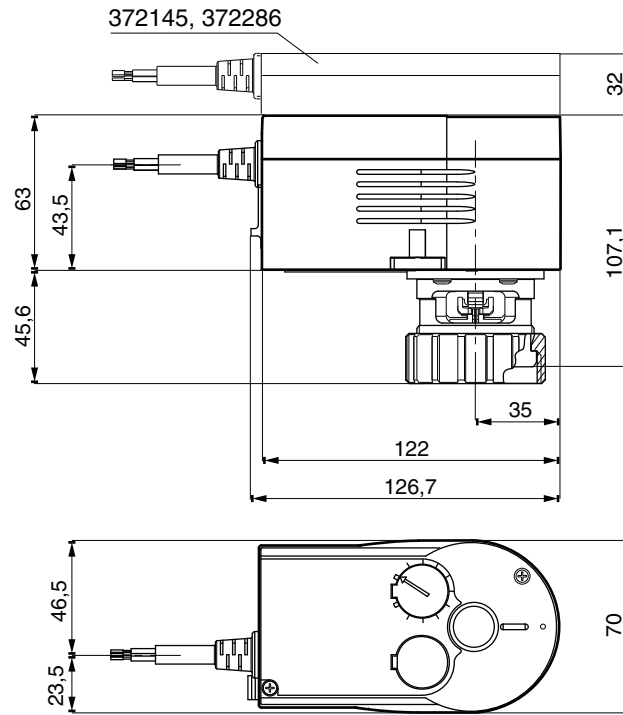

Accessories

