

de LCD Digital Thermostat
 fr Thermostat numérique LCD
 en LCD Digital Thermostat
 it Termostato digitale LCD
 es Termostato digital LCD
 sv LCD-digitaltermostat
 nl Digitale thermostaat met lcd-scherm

de Montagevorschrift
 fr Instruction de montage
 en Fitting instructions
 it Istruzioni di montaggio
 es Instrucciones de montaje
 sv Monteringanvisning
 nl Montagevoorschrift

NRFC413MF111
 NRFC422MF111
 NRFC423MF111
 NRFC424MF112

de Installationsanweisung für die Elektrofachkraft
 fr Notice d'installation pour l'électricien
 en Guidelines for the electrician
 it Informazioni per l'installatore elettrico
 es Instrucciones de instalación para el electricista
 sv Installationsinstruktion för behörig elektriker
 nl Installatie aanwijzing voor de elektromonteur

de Verschmutzungsgrad II, Überspannungskategorie II, nach EN 60730
 fr Degré de pollution II, catégorie surtension II, selon EN 60730
 en Pollution degree II, over voltage category II, as per EN 60730
 it Grado di insudiciamento II, categoria di sovratensione II, a norme EN 60730
 es Grado de suciedad II, Categoría de altatensión II, según EN 60730
 sv Grad av nedsmutsningsgrad II, Överspanningskategori II, enligt EN 60730
 nl Vervuilingsgraad II, Overspanningscategorie II, volgens EN 60730



1

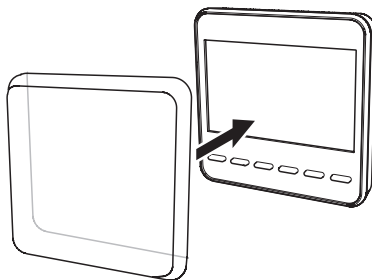

de Nur als Schutz während der Bauzeit
 fr À utiliser comme protection uniquement pendant le montage.
 en Only as protection during the construction period
 it Solo come protezione durante il periodo di costruzione.
 es Únicamente como protección durante la fase de construcción.
 sv Endast som skydd under byggtiden
 nl Alleen als bescherming tijdens de bouwperiode.

2

[mm]

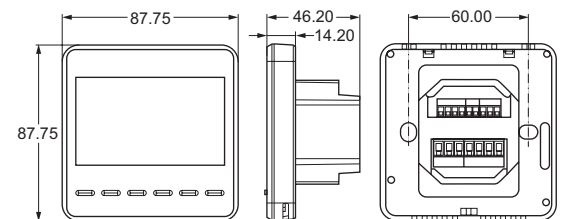

3

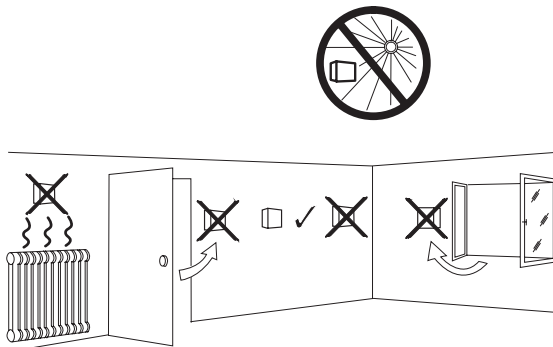

4

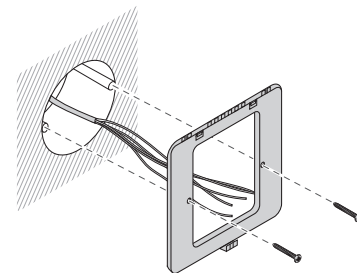

5

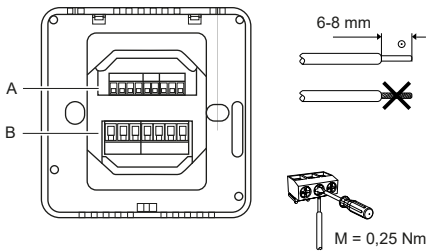

Rigid wiring

A	0.14 ... 1.5 mm ²
B	1.0 ... 1.5 mm ²

6

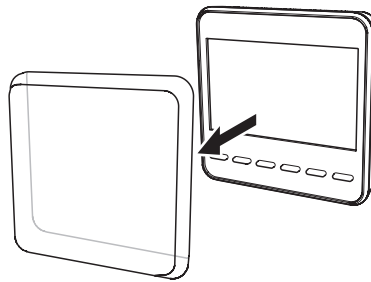

7

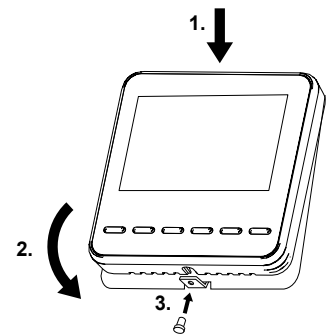

8

⚠ GEFAHR Lebensgefahr durch Stromschlag!

- Netzspannung führende Teile befinden sich hinter dem Deckel.
- Das Gerät darf nur durch eine qualifizierte Elektrofachkraft oder das Servicepersonal des Herstellers geöffnet werden.
 - Vor Beginn jeglicher Tätigkeit an den elektrischen Anschlüssen, das Gerät vom Netz trennen.
 - Das Gerät erst nach vollständiger Montage und geschlossenem Gehäuse unter Spannung setzen.
 - Das Gerät im offenen Zustand nicht unbeaufsichtigt lassen, um den Zugang von Laien und insbesondere Kinder zu verhindern.
 - Keine Gegenstände in die Gehäuseöffnungen einführen oder fallen lassen.
 - Beschädigte Geräte vom Netz trennen.

⚠ DANGER Attention, danger de mort par électrocution!

- Les parties sous tension se trouvent derrière le couvercle.
- Seul un électricien qualifié ou le personnel de maintenance du fabricant est autorisé à ouvrir l'appareil.
 - Avant toute intervention sur les raccordements électriques, déconnectez l'alimentation électrique de l'appareil.
 - Ne mettez l'appareil sous tension qu'après avoir terminé tous les travaux de montage et fermé le boîtier de l'appareil.
 - Ne laissez jamais l'appareil ouvert sans surveillance pour éviter que des personnes non qualifiées et en particulier les enfants puissent toucher l'appareil dans cet état.
 - Ne pas introduire ou laisser tomber des objets dans les ouvertures du boîtier.
 - Couper l'alimentation de tout appareil défectueux.

⚠ DANGER Danger of electrocution!

- The removal of this cover exposes parts which carry mains voltage.
- The unit should be opened only by a qualified electrician or by the manufacturer's service personnel.
 - Before starting any work on the electrical connections, separate the unit from the mains power supply.
 - Do not apply power to the unit until it has been completely reassembled and the housing has been closed.
 - To prevent access by unqualified persons and, in particular, children, do not leave the opened unit unattended.
 - Do not insert any objects, or allow any objects to fall, into the housing's slits.
 - Disconnect any damaged devices from the mains power supply.

⚠ PERICOLO Sussiste pericolo di morte a causa di scossa elettrica!

- Le parti conduttrici di tensione di rete si trovano dietro il coperchio.
- L'apparecchio deve essere aperto solo da un elettricista specializzato qualificato o dal personale del servizio assistenza della casa produttrice.
 - Prima d'iniziare qualsiasi attività di collegamento elettrico, staccare l'apparecchio dalla rete.
 - Mettere l'apparecchio sotto tensione solo dopo avere completato il montaggio e chiuso la custodia.

- Non lasciare l'apparecchio aperto privo di sorveglianza, per impedire l'accesso di non addetti ai lavori ed in particolare di bambini.
- Non introdurre o lasciare cadere oggetti nelle aperture della custodia.
- Staccare dalla rete gli apparecchi danneggiati.

⚠ PELIGRO Existe peligro de muerte por descarga eléctrica!

- Los componentes con tensión de alimentación se encuentran detrás de la tapa.
- Al aparato sólo debe abrirse por un técnico electricista cualificado o por el personal de mantenimiento del fabricante.
 - Desconecte el aparato de la red antes de desarrollar cualquier actividad en las conexiones eléctricas.
 - No aplique tensión al aparato hasta que el montaje haya finalizado y la caja se encuentre cerrada.
 - Procure no dejar abierto al aparato involuntariamente para impedir el acceso a legos, especialmente a niños.
 - No insertar objetos o permitir que caigan objetos al interior de las aberturas de la carcasa.
 - Desconectar de la red de alimentación los dispositivos dañados.

⚠ FARA Fara för strömstöt!

- Borttagande av denna kapsling medför att det finns delar åtkomliga som har matningsspänning på sig.
- Endast behörig elektriker eller instruerad servicepersonal får öppna enheten.
 - Innan något arbete med de elektriska anslutningarna påbörjas, måste enheten skiljas från huvudkraftmatningen.
 - Enheten får ej spänningssättas innan den är helt sammansatt och kapslingen stängd.
 - Enheten får ej lämnas obevakad när den är öppen (Förhindra icke behöriga och speciellt barn, från att ha tillgång till enheten).
 - Peta ej in saker, eller låt inga främmande föremål komma in i kapslingen.
 - Koppla ifrån alla skadade eller felaktiga enheter från kraftförsörjningen.

⚠ GEVAAR Gevaar voor elektrocutie.

- Spanningvoerende delen bevinden zich onder het deksel.
- De apparaat mag alleen door gekwalificeerde elektrotechnici of servicemedewerkers van de fabrikant worden geopend.
 - Voor aanvang van werkzaamheden aan de elektrische aansluiting, het apparaat van het lichtnet scheiden.
 - Het apparaat pas na volledige montage en met gesloten behuizing weer onder spanning zetten.
 - Apparaat in geopende toestand niet zonder toezicht achterlaten en de toegang verhinderen van onbevoegden en in het bijzonder kinderen.
 - Geen voorwerpen in de openingen laten vallen of naar binnen leiden.
 - Beschadigde apparatuur van netspanning halen.

- de Die Klemmenblöcke variieren je nach gewählter Anwendung. Bitte prüfen Sie zuerst die nebenstehende Tabelle.
Die Relaisausgänge sind netzspannungsführend und intern mit Klemme „L“ verbunden.
- fr Les blocs de bornes sont différents en fonction de l'application choisie. Veuillez d'abord vous référer au tableau ci-dessous.
Les sorties sur relais sont branchées à la tension secteur ; elles sont raccordées au terminal « L » de manière interne.
- en Terminal blocks change depending on the application selected, please check the table beside first.
The relay outputs are line voltage, they are connected with terminal "L" internally.
- it Le morsettiere cambiano a seconda dell'applicazione selezionata, si prega di controllare prima la tabella a fianco.
Le uscite a relè sono a tensione di linea, sono collegate internamente con il terminale "L".
- es Los bloques de terminales varían según la aplicación seleccionada; ver primero la tabla adyacente.
Las salidas de relé son de tensión de línea y están conectadas internamente con el terminal "L".
- sv Plintblock varierar beroende på vilken applikation som väljs. Kontrollera tabellen intill först.
Reläutgångarna är nätspänning, de är internt anslutna med plint "L".
- nl De klemmenblokken veranderen afhankelijk van de gekozen toepassing. Raadpleeg eerst de tabel hiernaast.
De relaisuitgangen staan onder netspanning. Ze zijn intern verbonden met klem "L".

	de	fr	en	it	es	sv	nl
	Schraubklemmenblock	Bloc de bornes à vis	Screw terminal block	Morsettiere a vite	Tornillo bloque de terminales	Skruvplintblock	Schroef klemmenblok
	Starre Verdrahtung	Câblage rigide	Rigid wiring	Cablaggio rigido	Cableado rígido	Fast ledningsdragnig	Starre bekabeling
AI	Analogeingang	Entrée analogique	Analog input	Ingresso analogico	Entrada analógica	Analog ingång	Analoge ingang
AO	Analogausgang	Sortie analogique	Analog output	Uscita analogica	Salida analógica	Analog utgång	Analoge uitgang
A	D+	D+	D+	D+	D+	D+	D+
B	D-	D-	D-	D-	D-	D-	D-
COM	Gemeinsam	Commun	Common	Insieme	Común	Gemensamt	Common (gemeenschappelijk)
CMP	Kompressor	Compresseur	Compressor	Compressore	Compresor	Kompressor	Compressor
FAN	ECM-Ventilator	Ventilateur ECM	ECM Fan	Ventola ECM	Ventilador ECM	ECM-fläkt	ECM-ventilator
F-ON	Ventilatoransteuerung	Activation du ventilateur	Fan activation	Attivazione ventola	Activación del ventilador	Fläktaktivering	Ventilatoractivering
GND	Signalmasse	Masse	Signal ground	Massa del segnale	Señal de tierra	Signaljord	Signaalaarde
HI	Ventilator Drehzahl hoch	Vitesse du ventilateur rapide	Fan speed high	Velocità ventola alta	Velocidad alta del ventilador	Fläktastighet hög	Ventilatorsnelheid hoog
LOW	Ventilator Drehzahl niedrig	Vitesse du ventilateur basse	Fan speed low	Velocità ventola bassa	Velocidad baja del ventilador	Fläktastighet låg	Ventilatorsnelheid laag
L	Stromführende Leitung	Fil sous tension	Live wire	Filo sotto tensione	Cable bajo tensión	Strömförande ledning	Draad onder stroom
MED	Ventilator Drehzahl mittel	Vitesse du ventilateur moyenne	Fan speed medium	Velocità ventola media	Velocidad media del ventilador	Fläktastighet medel	Ventilatorsnelheid gemiddeld
N	Neutralleiter	Conducteur neutre	Neutral conductor	Conduttore neutro	Conductor neutro	Neutralledare	Nulleider
n.c.	Nicht angeschlossen	Non connecté	not connected	Non connesso	No conectado	Ej ansluten	Niet verbonden
NTC	NTC-Fühler Typ II	Capteur NTC type II	NTC Typ II sensor	Sensore II di tipo NTC	Sensor NTC tipo II	NTC typ II-sensor	NTC type II-sensor
OCC	Digitaleingang	Entrée numérique	Digital input	Ingresso digitale	Entrada digital	Digital ingång	Digitale ingang
RV	Kälteventil	Vanne de réfrigération	Refrigeration valve	Valvola di refrigerazione	Válvula de refrigeración	Kylventil	Koelklep
TiO2 ESP	Elektrostatischer Filter	Filtre électrostatique	Electrostatic filter	Filtro elettrostatico	Filtro electrostático	Elektrostatiskt filter	Elektrostatisch filter
VAL#	Ventil	Vanne	Valve	Valvola	Válvula	Ventil	Klep
	2-Rohr proportional mit PICV	2 tubes, proportionnel avec PICV	2-pipe proportional with PICV	Proporzionale a 2 vie con PICV	De 2 tubos proporcional con PICV	2-rörs proportionell med PICV	2-weg proportioneel met PICV
	#-Rohr EIN/AUS 3-Stufen-Ventilator	# tubes, ON/OFF, ventilateur à 3 vitesses	#-pipe ON/OFF 3 speed fan	A # vie ON/OFF ventola a 3 velocità	De # tubos ON/OFF ventilador de 3 velocidades	#-rörs PÅ/AV trestegsfläkt	#-weg AAN/UIT 3 snelheden ventilator

de	fr	en	it	es	sv	nl
2-Rohr EIN/AUS 3-Draht-Ventil	2 tubes, ON/ OFF, vanne 3 fils	2-pipe ON/OFF 3 wires valve	A 2 vie ON/OFF valvola a 3 fili	De 2 tubos ON/ OFF válvula de 3 cables	2-rörs PÅ/ AV ventil med 3 ledningar	2-weg AAN/UIT 3 draden klep
2-Rohr EIN/AUS mit TiO ₂ /ESP	2 tubes, ON/OFF avec TiO ₂ /ESP	2-pipe ON/OFF with TiO ₂ /ESP	A 2 vie ON/OFF con TiO ₂ /ESP	De 2 tubos ON/ OFF con TiO ₂ / ESP	2-rörs PÅ/AV med TiO ₂ /ESP	2-weg AAN/UIT met TiO ₂ /ESP
2-Rohr EIN/ AUS mit Fussbodenheizung	2 tubes, ON/OFF avec chauffage au sol	2-pipe ON/OFF with floor heating	A 2 vie ON/OFF con riscaldamento a pavimento	De 2 tubos ON/OFF con calefacción radiante por suelo	2-rörs PÅ/AV med golvvärme	2-weg AAN/ UIT met vloerverwarming
Wasserquelle Wärmepumpe	Pompe à chaleur eau/eau	Water source heat pump	Pompa di calore ad acqua	Bomba de calor de agua geotérmica	Vattenkälla värmepump	Waterbron warmtepomp
#-Rohr EIN/AUS mit ECM-Ventilator	# tubes, ON/OFF avec ventilateur ECM	#-pipe ON/OFF with ECM Fan	A # vie ON/OFF con ventola ECM	De # tubos ON/OFF con ventilador ECM	#-rörs PÅ/AV med ECM-fläkt	#-weg AAN/ UIT met ECM- ventilator
2-Rohr proportional mit ECM	2 tubes, proporti- onnel avec ECM	2-pipe propor- tional with ECM	A 2 vie proporzio- nale con ECM	De 2 tubos proporcional con ECM	2-rörs proportio- nell med ECM	2-weg proportio- neel met ECM
Parameter ## auf ## gesetzt	Paramètre ## réglé sur ##	parameter ## set to ##	parametro ## impostato su ##	Parámetro ## ajustado a ##	Parameter ## inställd på ##	parameter ## ingesteld op ##

NRFC413MF111

Terminal block designation	Function
	n.c.
	n.c.
←L	Live wire
HI	Fan speed high
MED	Fan speed medium
LOW	Fan speed low
←N	Neutral conductor

Terminal block designation	Function
GND	Signal ground
AI	Valve position feedback
AO	Valve control signal
GND	Signal ground
NTC	NTC Type II sensor
OCC	Occupancy contact
COM	COM
B	D+
A	D-

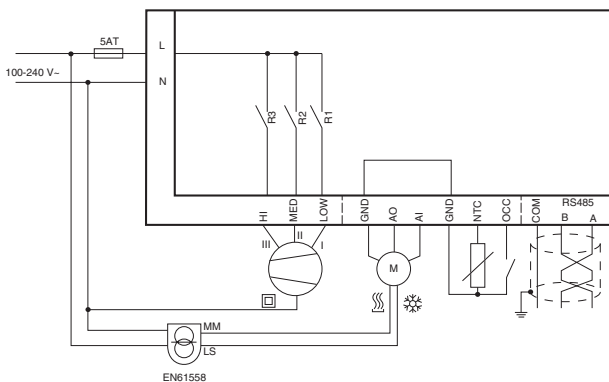
**2-pipe proportional with PICV
(not configurable)**



NRFC422MF111

Terminal block designation	Function
VAL1	Valve / compressor
VAL2	Valve / electrostatic filter
←L	Live wire
HI	Fan speed high
MED	Fan speed medium
LOW	Fan speed low
←N	Neutral conductor

Terminal block designation	Function
GND	Signal ground
NTC	NTC Type II sensor
OCC	Occupancy contact
COM	COM
B	D+
A	D-

**2-pipe ON/OFF 3 speed fan
(parameter 03 set to 00)**

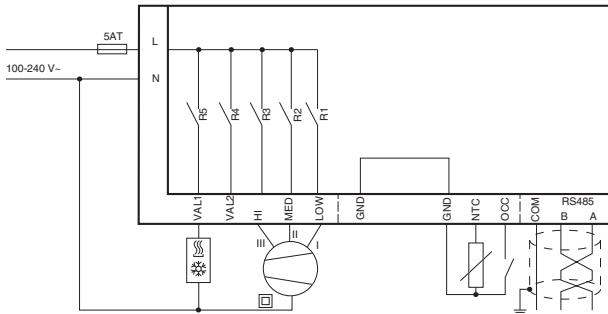

**4-pipe ON/OFF 3 speed fan
(parameter 03 set to 01)**

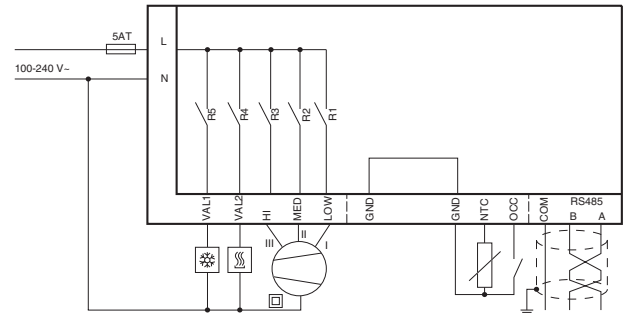

**2-pipe ON/OFF 3 wires valve
(parameter 03 set to 02)**

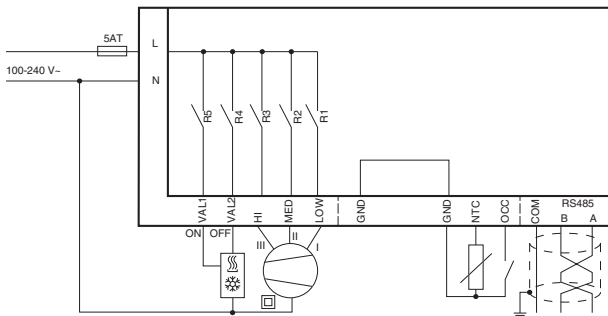

**2-pipe ON/OFF with TiO2/ESP
(parameter 03 set to 03)**

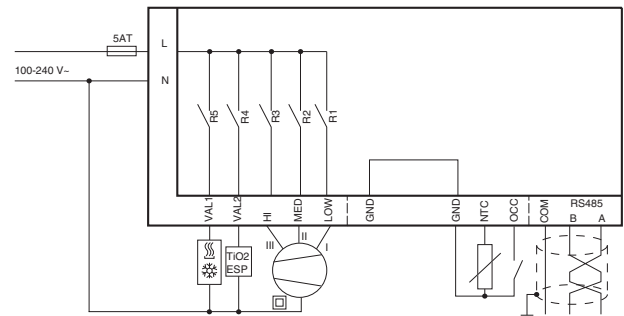

**2-pipe ON/OFF with floor heating
(parameter 03 set to 04)**

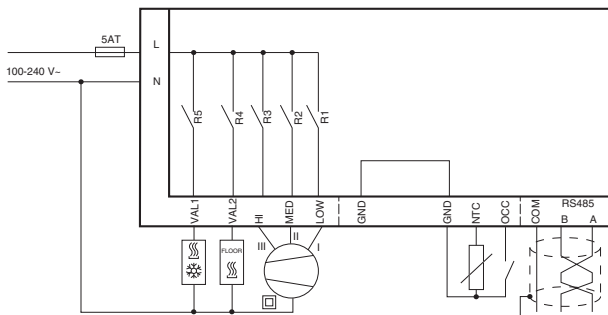

**Water source heat pump
(parameter 03 set to 05)**

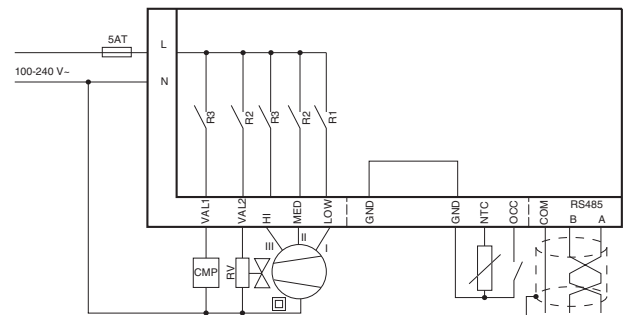

NRFC423MF111

Terminal block designation	Function
	n.c.
	n.c.
←L	Live wire
HI	Fan speed high
MED	Fan speed medium
LOW	Fan speed low
←N	Neutral conductor

Terminal block designation	Function
GND	Signal ground
A02	Valve control signal
A01	Valve control signal
GND	Signal ground
NTC	NTC Type II sensor
OCC	Occupancy contact
COM	COM
B	D+
A	D-

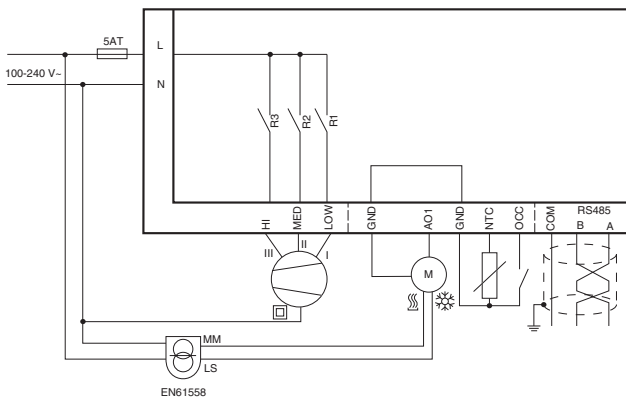
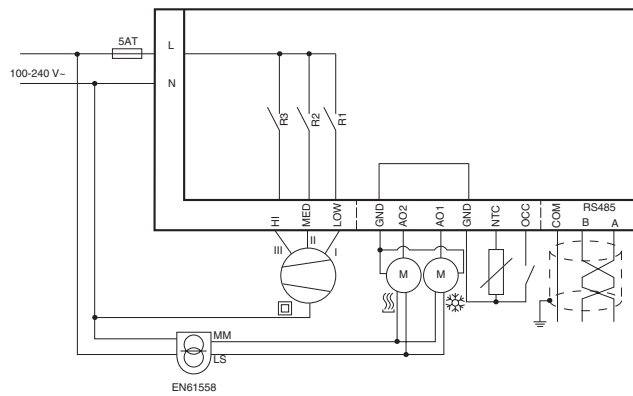
**2-pipe proportional 3 speed fan
(parameter 03 set to 00)**

**4-pipe proportional 3 speed fan
(parameter 03 set to 01)**

NRFC424MF112

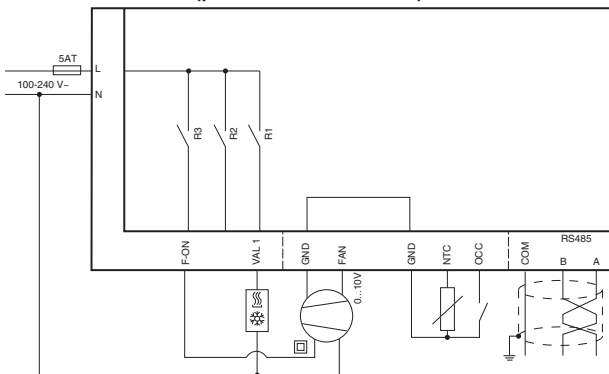
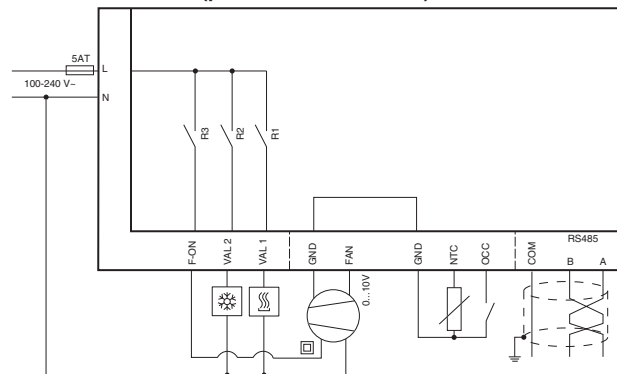
Terminal block designation	Function
	n.c.
	n.c.
←L	Live wire
F-ON	Fan activation
VAL2	Valve / Compressor
VAL1	Valve / Electrostatic filter
←N	Neutral conductor

Terminal block designation	Function
GND	Signal ground
FAN	ECM Fan
A01	Valve control signal
GND	Signal ground
NTC	NTC Type II sensor
OCC	Occupancy contact
COM	COM
B	D+
A	D-

**2-pipe ON/OFF with ECM Fan
(parameter 03 set to 00)**

**4-pipe ON/OFF with ECM Fan
(parameter 03 set to 01)**

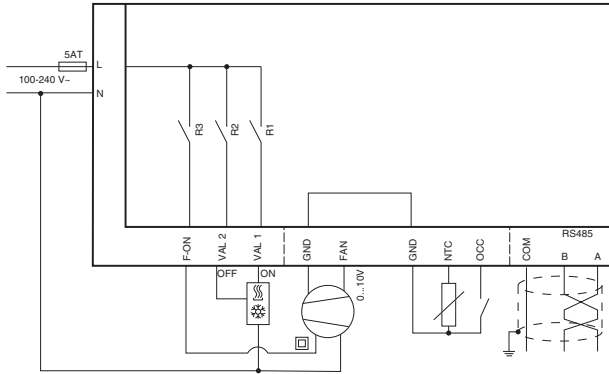

NRFC424MF112

**2-pipe ON/OFF 3 wires valve
(parameter 03 set to 02)**



**2-pipe ON/OFF with TiO2/ESP
(parameter 03 set to 03)**

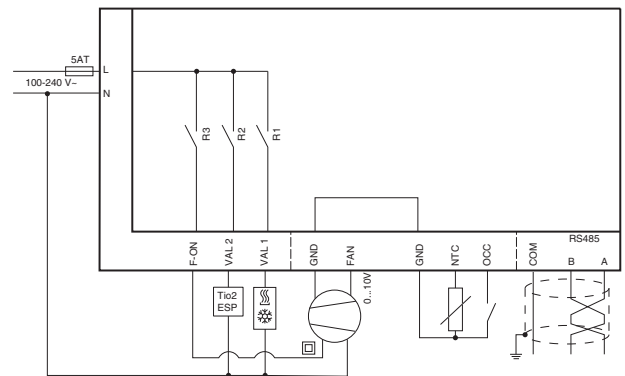

**2-pipe ON/OFF with floor heating
(parameter 03 set to 04)**

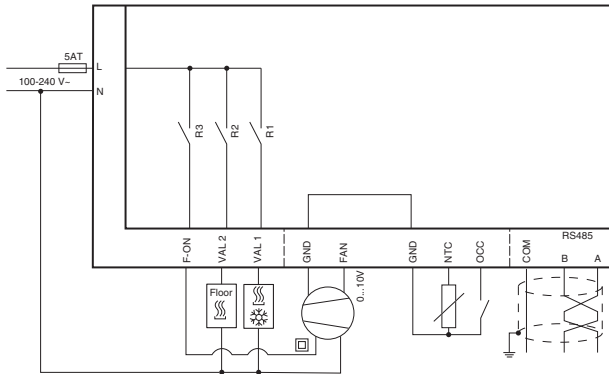

**Water source heat pump
(parameter 03 set to 05)**

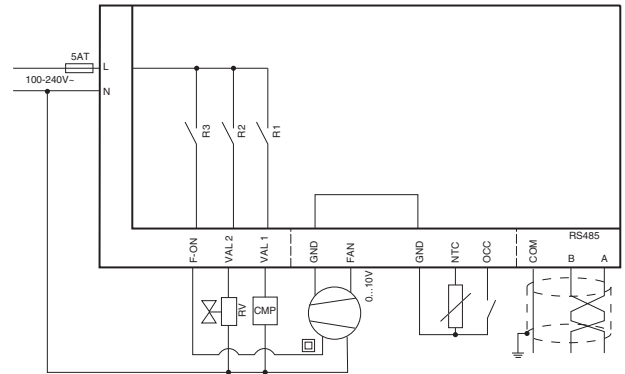

**2-pipe Proportional with ECM
(parameter 03 set to 06)**

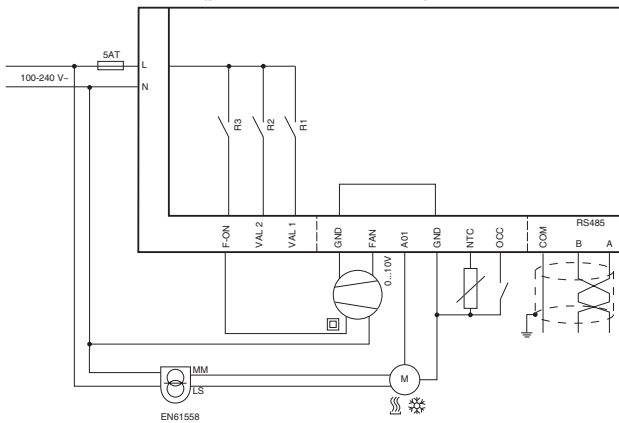

9

de RS-485 Busanschluss
 fr Raccordement du bus RS-485
 en RS-485 bus connection
 it Collegamento bus RS-485
 es Conexión de bus RS-485
 sv RS-485 bussanslutning
 nl RS-485 busaansluiting

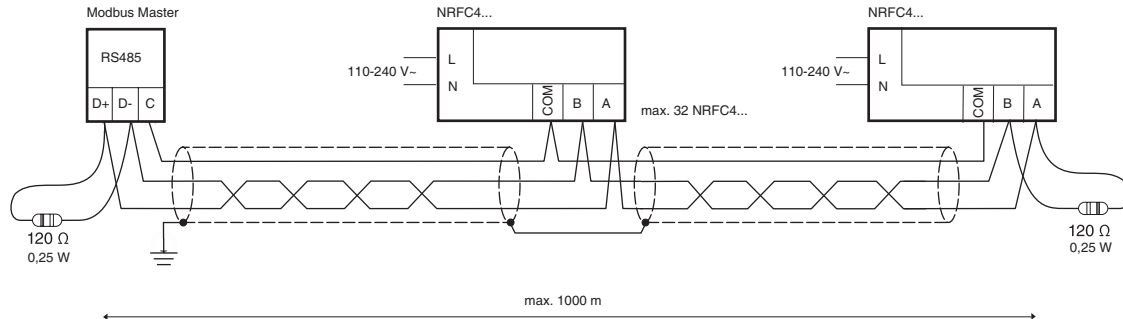

HINWEIS

Für Buslängen bis max. 1000 m empfehlen wir die Verwendung der unten aufgeführten Kabel.

AVIS

Nous recommandons l'utilisation des câbles indiqués ci-dessous pour des longueurs de bus de 1000 m maximum.

NOTICE

For bus lengths up to max. 1000 m, we recommend using the cables listed below.

AVVISO

Per lunghezze bus fino a un max di 1000 m, si consiglia l'utilizzo dei cavi elencati qui di seguito.

AVISO

Para buses de máx. 1000 m de longitud, recomendamos utilizar los cables indicados más abajo.

OBS !

För buslängder på upp till max. 1000 m rekommenderar vi att nedanstående kablar används.

LET OP

Voor buslengtes tot max. 1000 meter adviseren we het gebruik van de hieronder vermelde kabels.

- Lapp UNITRONIC® BUS LD 2170204
- Lapp UNITRONIC® BUS LD FD P 2170214
- Belden 9842
- Belden 3106A
- Belden 3107A

de Dokument aufbewahren
 fr Ce document est à conserver
 en Retain this document
 it Conservare il documento
 es Guardar el documento
 sv Spara dokumentationen
 nl Document bewaren

© Fr. Sauter AG
 Im Surinam 55
 CH-4058 Basel
 Tel. +41 61 - 695 55 55
 Fax +41 61 - 695 55 10
 www.sauter-controls.com
 info@sauter-controls.com

de www.sauter-controls.com ↻ Produkte ↻ MD Datenblatt
 fr www.sauter-controls.com ↻ Produits ↻ Fiche MD
 en www.sauter-controls.com ↻ Products ↻ MD Datasheet
 it www.sauter-controls.com ↻ Products ↻ MD Datasheet
 es www.sauter-controls.com ↻ Products ↻ MD Datasheet
 sv www.sauter-controls.com ↻ Products ↻ MD Datasheet
 nl www.sauter-controls.com ↻ Products ↻ MD Datasheet
 UK Importer: Sauter (GB) Inova House RG24 8GG