



SAUTER flexotron800 V2 Heating

User Manual
P100013566

Contents

1	General information	9
1.1	Disclaimer	9
1.2	Trademark	9
2	About the user manual	11
2.1	Further information	11
3	Regarding the flexotron800	13
3.1	New features in version 3.3	13
3.2	Selecting the application	13
3.2.1	Other menu items	14
3.3	Select language	15
3.4	Heating user program	15
3.5	Overview of flexotron800 hardware	17
3.6	Overview of flexotron800 models	17
3.7	Technical data	18
3.7.1	flexotron800 terminal assignment	19
4	Installation and terminal assignment	21
4.1	Installation	21
4.2	Terminal assignment	22
4.2.1	Power supply	22
4.2.2	Inputs and outputs	22
4.2.3	List of the inputs and outputs	25
5	Commissioning	37
5.1	General information	37
5.2	Step-by-step	37
6	Functions	41
6.1	Heating control	41
6.1.1	General information	41
6.1.2	Controllers	41
6.1.3	Control characteristics	41
6.1.4	Adjusting the characteristics	41
6.1.5	Temperature limit values	41
6.1.6	Priority of heating over hot water	42
6.1.7	Pump control	42
6.1.8	Frost-protection facility	42
6.1.9	Wind compensation	43
6.1.10	Building inertia and boost	43
6.1.11	Night reduction	44
6.1.12	Starting time optimisation	44
6.1.13	Power limitation	45
6.2	Cooling system	45
6.2.1	General information	45
6.2.2	Controllers	45

Contents

6.2.3	Dew point control	45
6.2.4	Pump control	45
6.2.5	Starting the cooling unit	46
6.2.6	Eco/comfort function	46
6.2.7	Temperature limiter	46
6.2.8	Bypass valve (frost protection in the primary cooling system)	46
6.3	Domestic hot water	46
6.3.1	General information	46
6.3.2	Controllers	46
6.3.3	Night reduction	46
6.3.4	Pump control (HW1 only)	47
6.3.5	Anti-legionellae function (HW1 only)	47
6.3.6	Priority of hot water over heating	47
6.4	Hot water preparation function	47
6.4.1	Priority of HP over HS	48
6.5	Pressure control	48
6.6	Boiler control	48
6.6.1	General information	48
6.6.2	Type of boiler control	48
6.6.3	Setpoint	51
6.6.4	Minimum running time and stop time	52
6.6.5	Starting sequence	52
6.6.6	Boiler test operation	52
6.6.7	Boiler alarm	52
6.6.8	Boiler pump	52
6.6.9	Transport pump	53
6.6.10	Return temperature in boiler	53
6.7	Extra control loop	54
6.8	Cold water consumption	54
6.8.1	Values	54
6.8.2	Alarm	54
6.9	Energy consumption	54
6.9.1	Consumption values	55
6.9.2	Performance values	55
6.9.3	Leakage monitoring	55
6.9.4	Alarm	55
6.10	Electricity meter	55
6.10.1	Consumption values	55
6.11	Extra timer outputs	56
6.12	Alarm	56
6.12.1	Alarm handling	56
6.12.2	Alarm priority	56
6.12.3	Alarm text	56
7	Display, LEDs and buttons	57
7.1	Display	57
7.2	LEDs	57
7.3	Buttons	57
7.4	Menu navigation	58

8	Access rights	61
8.1	Log on	61
8.2	Log off	62
8.3	Change code	62
8.4	Forgotten password	62
8.5	Change the password to deactivate automatic logout	63
9	Configuration	65
9.1	Alarm settings	65
9.1.1	Alarm limits	65
9.1.2	Alarm delay	67
9.2	Inputs and outputs	68
9.2.1	General information	68
9.2.2	Analogue inputs AI	68
9.2.3	Digital inputs DI	69
9.2.4	Universal inputs UI	69
9.2.5	Analogue outputs AO	70
9.2.6	Digital outputs DO	70
9.3	Sensor settings	70
9.4	Supply	71
9.4.1	Parallel displacement	72
9.4.2	Maximum limitation	72
9.4.3	Minimum limitation	72
9.4.4	Setpoint auto-correct	72
9.4.5	Wind compensation	73
9.4.6	Optimisation	74
9.4.7	Power limitation	75
9.4.8	Control function CS1	75
9.4.9	Dew point control	75
9.4.10	Heat demand to AO	76
9.4.11	Heat demand AI	76
9.5	Return temperature limit	77
9.5.1	Maximum return temperature	77
9.5.2	Max delta-T HP/H	77
9.5.3	Minimum return temperature	78
9.5.4	Return limitation factor	78
9.6	Boiler control	78
9.6.1	General information	78
9.6.2	Boiler 1 to 4	79
9.6.3	Pumps	80
9.7	Pump stop	81
9.8	Twin/single pump	82
9.9	Operating mode/motor protection	83
9.10	Type of actuator	84
9.11	Actuator run time, 3-point actuators	84
9.12	Anti-jamming function	85
9.13	Leakage monitoring	85
9.14	Pulse inputs	86
9.15	Alarm configuration	86

Contents

9.16	Communication	92
9.16.1	Modbus communication	92
9.16.2	BACnet communication	93
9.16.3	Dial-up modem	93
9.16.4	Alarm forwarding via SMS	94
9.17	Other parameters	94
9.17.1	General information	94
9.17.2	HW1	96
9.17.3	HP1	96
9.18	System	97
9.18.1	Changing the language	97
9.18.2	Selecting the start display – text normally shown	97
9.18.3	Automatic summer/winter time change-over	98
9.18.4	Controller bus address	99
9.18.5	Remote operation using the display	99
9.18.6	Automatic logout	99
10	Settings	101
10.1	Actual/setpoint	102
10.1.1	HS1, HS2 and HS3	102
10.1.2	CS1	103
10.1.3	HW1 and HW2	105
10.1.4	HP1	106
10.1.5	Boiler	106
10.1.6	Extra control loop	108
10.2	Temperature control	108
10.2.1	General information	108
10.2.2	HS1, HS2 and HS3	108
10.2.3	CS1	109
10.2.4	HW1 and HW2	109
10.2.5	Boiler	109
10.3	Manual/auto	110
10.3.1	General information	110
10.3.2	HS1, HS2 and HS3	110
10.3.3	CS1	111
10.3.4	HW1 and HW2	111
10.3.5	HP1	112
10.3.6	Boiler	112
10.3.7	Extra control loop	114
10.4	ECO/comfort function	114
10.4.1	General information	114
10.4.2	HS1, HS2, HS3, HW1, HW2 and CS1	114
10.5	Time/Timer outputs	116
10.5.1	General information	116
10.5.2	Time/Date	116
10.5.3	Timer outputs	116
10.6	Holiday	117
10.7	Energy/Cold water	117
10.7.1	Heating meter	117

10.7.2	Cold water meters for CW1 and CW2	118
10.7.3	Electricity meter	118
10.7.4	Leakage monitoring	118
10.8	Running mode	119
10.8.1	Alarms	119
10.8.2	Inputs/Outputs	119
10.8.3	Extra sensors	120
11	Expansion units	121
11.1	RS485 interfaces	121
11.2	Connection	121
11.2.1	Expansion units	121
12	Other functions	123
12.1	Alarm handling	123
12.2	Status indicators	124
12.3	Changing the battery	124
12.4	Individual text field	126
12.5	Version number	126

1 General information

1.1 Disclaimer

The information in this user manual has been carefully checked and judged to be correct. Fr. Sauter AG makes no guarantee regarding the content of this manual and requests the reader to report any errors, inaccuracies or unclear formulations so that they can be corrected. The information in this document is subject to change without notice.

The software described in this document is supplied under licence and may be used or copied only in accordance with the terms of the licence. No part of this document may be reproduced or transmitted in any form, electronically or mechanically, without the express, written permission of Fr. Sauter AG.

1.2 Trademark

flexotron is a registered trademark of Fr. Sauter AG.

Windows, Windows 2000, Windows XP, Windows Vista, Windows 7, Windows 8 and Windows Server 2003 are registered trademarks of the Microsoft Corporation.

Some product names mentioned in this document are used for identification purposes only and are the registered trademarks of their respective companies.

Revision status A, August 2014.

Software version: 3.3

2 About the user manual

This user manual covers all the models in the flexotron800 series used for heating control. This revised version contains program functions for software version 3.3.

2.1 Further information



More information about flexotron800 can be found in the following documents:

flexotron800 ventilation user manual – complete user manual for configuring and operating the flexotron800 ventilation controller, available in English, German and French.

CASE flexotron user manual – user manual for configuring the controllers using the CASE flexotron PC software, available in English, German and French.

Network variables – list of variables for Modbus and BACnet communication, available in English.

CE declaration of conformity, flexotron800



This information can be downloaded from www.sauter-controls.com/en.

3 Regarding the flexotron800

The flexotron800 series comprises three sizes of model, with 8, 15 or 28 inputs and outputs.

In each model of flexotron800, all user programs are loaded in a separate memory area. From version 3.3, models are available with two or three communication interfaces. All functions and configurations can be performed using the displays and buttons or using the CASE flexotron configuration tool, which is installed on a PC and connected via a communication cable.

The controllers are available with or without a display and buttons. For all controllers, an external RDB800 display with buttons can be connected via a cable.

The number of inputs and outputs on the controller can be increased by connecting one or two expansion units to the RS485 interface.

 The flexotron800 models with 2 and 3 interfaces are only available on request.

3.1 New features in version 3.3

- The operating system has been further optimised
- Now 2 and 3 communication interfaces are supported
- BACnet/IP has been introduced as the communication protocol
- It can be operated simultaneously via an integrated and an external display
- Heat requirement function
- Digital input for a longer comfort period

3.2 Selecting the application

On delivery, the main memory of the flexotron800 controller is empty. All the user programs are located in a separate memory area.

When it is started up, the controller starts a program to load the required application to the main memory.

```
RDT828  
PLA: 254 ELA: 30  
Baud#1: 9600  
Rev: 3.3-1-01
```

The first screen displays the model of the device, its communication address and communication speed, and the revision status of the installed controller.

To load the application to the main memory, press the [Down] button.

Regarding the flexotron800

```

→ Application
  System
  Communication
  Time/Date
    
```

Select "Application", then press the [Right] button.

```

flexotron800 Vent.
→ flexotron800 Heat.
  Expansion unit1
  Expansion unit2
    
```

Move the cursor to the desired application and press the [Right] button.

```

Title:
flexotron800 Heating 3.3
Activate? No
    
```

Press [OK] and change from NO to YES. Press [OK] again. The last heating application program that was downloaded is loaded to the RAM. This procedure takes around 30 seconds.

3.2.1 Other menu items

System:

Information on the flexotron800 model and the serial number.

- MAC address and IP address.
- Battery status and size of the memory.
- Memory status and voltage frequency.

Communication:

- Selection of the communication type.

Serial:

- Selection of the controller address, communication speed, interface mode and routing.

TCP/IP:

Here you can enter the controller address and select DHCP (YES/NO).

It is also possible to set the IP address and the subnet mask manually before starting the flexotron800. This menu also contains the default gateway and the DNS name:

- The current subnet mask, the gateway and the DNS name are displayed
- Status of the main computer
- IP address of the main computer
- Allow connection to main computer
- TCP port routing at serial interface 1 or 2

Time/Date:

Setting for time and date.

Input/Output:

Option to assign reading and writing function to inputs and outputs.

3.3 Select language

In the basic display, press the [Right] button three times to go to the language selection:

```
Heating
Choose language
English
Accept changes:No
```

Press [OK] to start language selection. Use the [Up] and [Down] buttons to select the language. Press [OK] to confirm.

After a few seconds, the start display for the selected application appears in English. If you selected a language other than English, the display then appears in the selected language.

```
Heating controller
08:06:03 09:32
HS1
Sp: 19.5 IW: 20.1°C
```

3.4 Heating user program

The temperature controllers are PI controllers for regulating heating circuits, cooling circuits and boilers, as well as PID controllers for regulating domestic hot water. These controllers can be linked to various control functions and to analogue and digital inputs and outputs. The user can freely select the functions and the inputs and outputs. The only restriction to this is the number of physical inputs and outputs on the various models.

The flexotron800 is designed for mounting on a DIN rail.

Regarding the flexotron800

Heating control includes the following functions among others:

Heating

Controlling 1 to 3 heating systems with weather-dependent supply and control options using room sensors and/or return sensors.

Optimisation function

Optimisation of the starting time for reaching the comfort temperature after lowering in ECO mode.

Cooling

Controlling a cooling system with dew point control. The setpoint can be fixed or weather-dependent.

Domestic hot water

Either one or two domestic hot water circuits and a hot water preparation control unit.

Additional control loop

Differential thermostat function for moving fluids between two points depending on the temperature difference.

Pump differential pressure control

A control loop for constant pressure.

Boiler control

For sequential control of 1 to 4 boilers: 1-step, 2-step or modulating burners. You can choose between a fixed setpoint, a weather-dependent setpoint or the highest of the other setpoints configured for the heating system.

Timer outputs

Up to 5 individually configurable clock channel outputs for controlling functions such as door locks and lighting.

Timer

Individual day programmes, holiday schedules, year-long clock.

Water consumption

Digital input for displaying water consumption.

Energy consumption

Digital input for displaying energy consumption.

3.5 Overview of flexotron800 hardware

Model	RDT808F012	RDT808F212	RDT815F012	RDT815F212	RDT815F022	RDT815F222	RDT815F032	RDT815F232	RDT828F012	RDT828F212	RDT828F022	RDT828F222	RDT828F032	RDT828F232
Analogue inputs	2	2	4	4	4	4	4	4	4	4	4	4	4	4
Digital inputs	3	3	4	4	4	4	4	4	8	8	8	8	8	8
Universal inputs*	–	–	–	–	–	–	–	–	4	4	4	4	4	4
Analogue outputs	1	1	3	3	3	3	3	3	5	5	5	5	5	5
Digital outputs	2	2	4	4	4	4	4	4	7	7	7	7	7	7
RS485	Yes	Yes	Yes	Yes	No	No	Yes	Yes	Yes	Yes	No	No	Yes	Yes
TCP/IP	No	No	No	No	Yes	Yes	Yes	Yes	No	No	Yes	Yes	Yes	Yes
Display	No	Yes	No	Yes	No	Yes	No	Yes	No	Yes	No	Yes	No	Yes
Ext. display	Op*	Op*	Op*	Op*	Op*	Op*	Op*	Op*	Op*	Op*	Op*	Op*	Op*	Op*
1 interface	Yes	Yes	Yes	Yes	Yes	Yes	No	No	Yes	Yes	Yes	Yes	No	No
2 interfaces	No	No	No	No	No	No	Yes	Yes	No	No	No	No	Yes	Yes

* Universal inputs (can be configured as analogue or digital inputs), Op=option

All flexotron800 V2 controllers support an external display.

3.6 Overview of flexotron800 models

Model with display	Model without display	Description
RDT808F212 RDT815F212 RDT828F212	RDT808F012 RDT815F012 RDT828F012	Standard controller with RS485 interface
RDT815F222 RDT828F222	RDT815F022 RDT828F022	Controller with a TCP/IP interface
RDT815F232 RDT828F232	RDT815F032 RDT828F032	Controller with RS485 interface and TCP/IP interface

Regarding the flexotron800

3.7 Technical data

Type of protection	IP 20 when installed
Display	4 lines of 20 characters Illumination
LEDs	
Yellow	Adjustable parameters
Red	Alarm indicator
Clock	
24-hour system clock with battery backup, automatic summer/winter changeover	
Power supply	24 V AC $\pm 15\%$, 50...60 Hz or 21...36 V DC
Power consumption	7.5 VA, 3.4 W (DC), TCP models: 8 VA, 3.7 W (DC)
Start-up current	28 A (2 ms)
Dimensions	148x123x58 (WxHxD including terminals)
Housing	Euronorm (8.5 modules wide)
Mounting	On a DIN rail
Operation	
Environmental conditions according to IEC 721-3-3	Class 3k5
Ambient temperature	0...50 °C
Ambient humidity	Max. 95% rh
Mechanical requirements according to IEC721-3-3	Class 3M3
Vibration	IEC60068-2-6, Test FC, sinusoidal vibration
Shock	IEC60068-2-27, Test Ea
Transport	
Ambient conditions according to IEC 721-3-2	Class 2k3
Ambient temperature	-20...70 °C
Ambient humidity	Max. 95% rh
Mechanical requirements according to IEC721-3-2	Class 2M2
Vibration	IEC60068-2-6, Test FC, sinusoidal vibration
Shock	IEC60068-2-27, Test Ea
Free fall	IEC60068-2-27, Test Ed
Storage	
Ambient conditions according to IEC 721-3-1	Class 1k3
Ambient temperature	-20...70 °C
Ambient humidity	Max. 95% rh
Battery	
Type	Replaceable lithium cell, CR2032
Battery life	More than 5 years
Warning	Low battery warning
Battery backup	Memory and clock
Communication	
The communication protocol depends on the selected model. The model that is suitable for the actual requirements must be selected.	
Protocol	Modbus/RTU, BACnet/IP
Interface	RS485, TCP/IP

EMC, standard for emissions and resistance to interference

The product fulfils the requirements of EMC Directive 2004/108/EC via the product standards EN 6100061 and EN 6100063.

RoHS

The product fulfils Directive 2011/65/EU of the European Parliament and the European Council.

Regarding the flexotron800

Inputs

Analogue inputs AI
 Digital inputs DI
 Universal inputs UI

Configurable as 0...10 V DC or Ni1000, 12 bit A/D
 Potential-free connection
 Can be used as either analogue or digital input
 (see information above)

Outputs

Analogue outputs AO

Configurable as 0...10 V DC; 2...10 V DC;
 10...0 V DC or 10...2 V DC
 8 bit D/A, short-circuit protected

Digital outputs DO

Mosfet outputs, 24 V AC/DC, constant 2 A. Max. 8 A total.

Optional

TCP models
 With 2 interfaces
 External operating unit, RDB800

Replaces the RS485 interface of flexotron800
 One serial interface and one TCP/IP interface
 Used for all flexotron800 models

3.7.1 flexotron800 terminal assignment

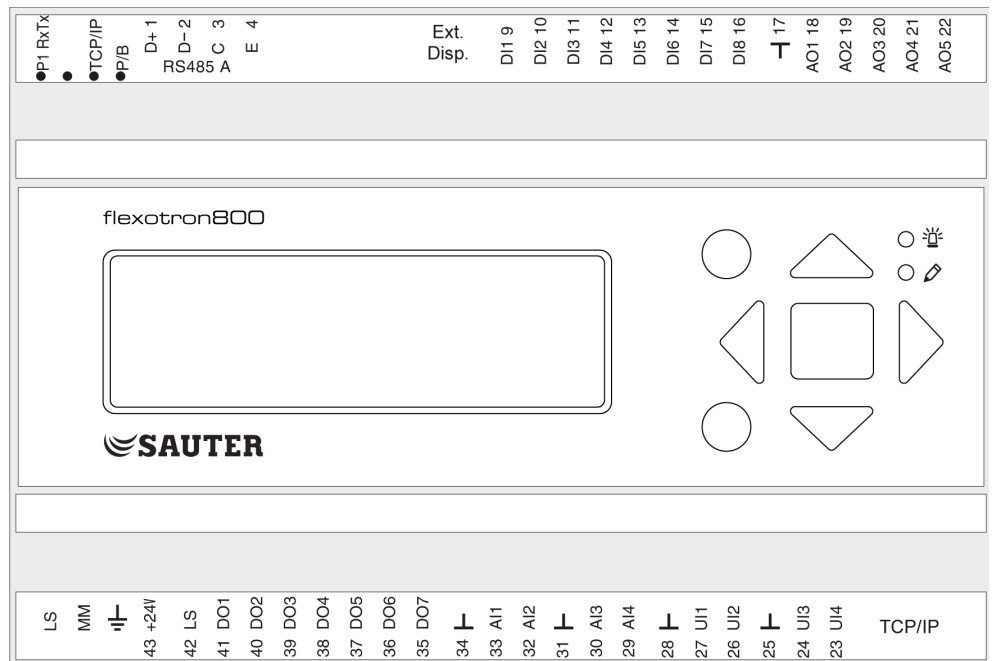

4 Installation and terminal assignment

4.1 Installation

The flexotron800 controller can be mounted in a DIN-standard housing (minimum 9 modules), on a DIN rail in a cabinet or, using a suitable mounting kit, in a cabinet door or control panel.

Ambient temperature: 0...50 °C.

Humidity: Max: 95% rh, non-condensing.

Example of terminal assignment on RDT828.

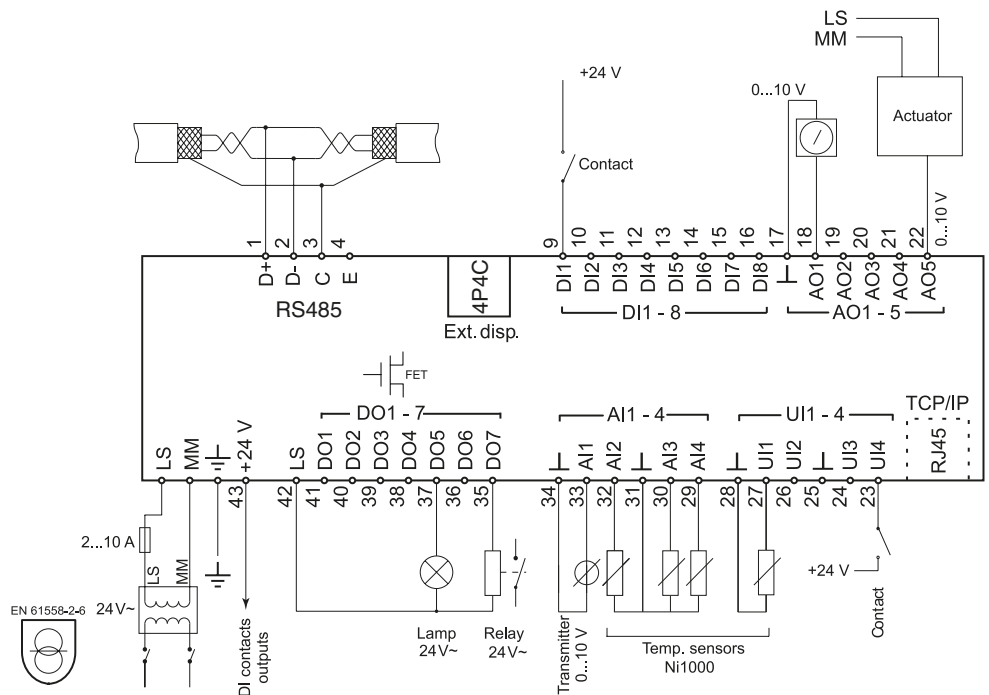

- Options:
- RDT828F022
 - RDT828F032
 - RDT828F222
 - RDT828F232
- RJ45
- TCP/IP

4.2 Terminal assignment

At the end of this section there are terminal assignment plans that show the available factory-set configurations as well as blank wiring diagrams. Because most functions of the inputs and outputs depend on the programming of the device, the definitive wiring diagram cannot be completed until the installer has assigned the inputs and outputs.

It is important to make sure that the wiring is correctly carried out in accordance with the instructions in this manual.

4.2.1 Power supply

24 V~ ±15%, 50...60 Hz or 21...36 V=



If the flexotron800 controller and the connected actuators are supplied by the same transformer, the same transformer pole must always be used as reference earth for the entire installation. If the reference earth is not the same, the equipment will not function properly and serious damage may occur.

4.2.2 Inputs and outputs

The list of inputs and outputs in section 4.2.3 provides an overview and helps you configure them.

Analogue inputs

Analogue inputs must be connected to an earth terminal in the same terminal block as the input.

Depending on the configuration, analogue inputs can be used either for Ni1000 temperature sensors or for 0...10 V DC analogue input signals, for example from a pressure transmitter.

Digital inputs

Digital inputs must be connected to the +24 V terminal. Digital inputs may only be connected with voltageless contacts. Any external voltage applied to a digital input may harm the unit.

Universal inputs

A universal input can be configured to act as either an analogue input or as a digital input.

Depending on the configuration, a universal input acting as an analogue input can be used for either Ni1000 temperature sensors or for 0...10 V DC analogue input signals, for example from a pressure transmitter.

Universal inputs configured as analogue inputs must be connected to an earth terminal in the same terminal block as the input.

A universal input configured as a digital input must be connected to terminal +24 V just like other digital inputs and may only be connected using voltageless contacts.

Analogue outputs

Analogue outputs must be connected to the earth terminal in the AO terminal block.

All analogue outputs can be individually configured for the following signals:

- 0...10 V DC
- 2...10 V DC
- 10...0 V DC
- 10...2 V DC



If the flexotron800 controller and the connected actuators are supplied by the same transformer, the same transformer pole must always be used as reference earth for the entire installation. If the reference earth is not the same, the equipment will not function properly and serious damage may occur.

Digital outputs

Digital outputs should normally be connected to terminal 42 LS. Terminal 42 LS is internally connected to LS and supplies 24 V~ or 24 V= depending on the power supply.

All the digital outputs are Mosfet transistors. The outputs are connected internally to LS and are restricted to not more than 2 A per output. The total load for all the digital outputs may not exceed 8 A.

A number of alternative terminal assignments are possible depending on the relay type and the power supply to the flexotron800 controller.

24 V~ power supply and 24 V~ relay

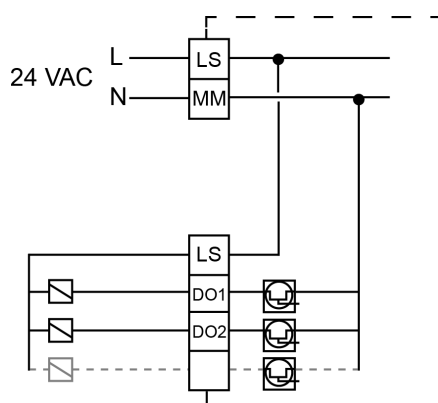

Installation and terminal assignment

24 V= power supply and 24 V= relay

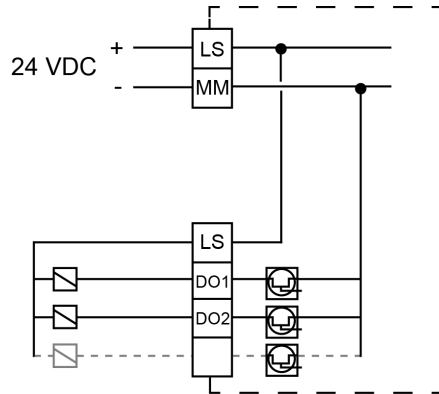

24 V~ power supply and 24 V= relay

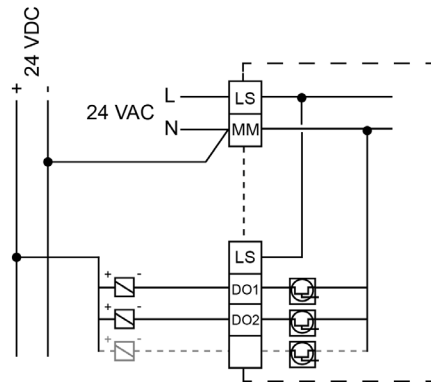

24 V= power supply and 24 V~ relay

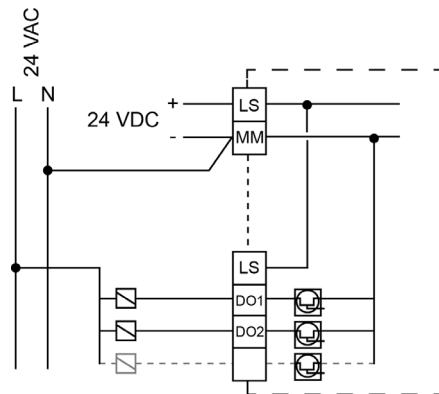

4.2.3 List of the inputs and outputs

Use the lists below during commissioning for a better overview of the required input and output configurations.

The left column contains a description of the input or output signal, the middle column shows the name of the signal in CASE flexotron and the right column shows the text displayed in the flexotron800 controller.

Analogue inputs

✓	Description	CASE flexotron	Display
	Outdoor-temperature sensor	Outdoor Temp	Outd Temp
	Supply temperature, heating system 1	HS1, Supply Temp	HS1 Supply
	Supply temperature, heating system 2	HS2, Supply Temp	HS2 Supply
	Supply temperature, heating system 3	HS3, Supply Temp	HS3 Supply
	Supply temperature, cooling system	CS1, Supply Temp	CS1 Supply
	Supply temperature, domestic hot water circuit 1	HW1, Supply Temp	HW1 Supply
	Supply temperature, domestic hot water circuit 2	HW2, Supply Temp	HW2 Supply
	Supply temperature, hot water preparation	HP1, Supply Temp	HP1 Supply
	Room temperature, heating system 1	HS1, Room Temp	HS1 Room
	Room temperature, heating system 2	HS2, Room Temp	HS2 Room
	Room temperature, heating system 3	HS3 Room Temp	HS3 Room
	Room temperature, cooling system Ni1000	CS1, Room Temp Ni1000	CS1 Room
	Room temperature, cooling system 0...10V	CS1, Room Temp 0-10V	CS1 Room (V)
	Return temperature, heating system 1	HS1, Return Temp	HS1 Return
	Return temperature, heating system 2	HS2, Return Temp	HS2 Return
	Return temperature, heating system 3	HS3, Return Temp	HS3 Return
	Return temperature, cooling system	CS1, Return Temp	CS1 Return
	Return temperature, hot water 1	HW1, Return Temp	HW1 Return
	Return temperature, hot water preparation	HP1, Return Temp	HP1 Return
	Wind sensor, 0...10 V DC	Wind speed	Wind
	Differential pressure sensor, 0...10 V DC	Diff pressure	Pressure

Installation and terminal assignment

✓	Description	CASE flexotron	Display
	Humidity sensor, 0...10 V	Relative humidity	RH
	Primary heating circuit, supply temperature	HP Supply Temp	HP Supply
	Primary heating circuit, return temperature	HP Return Temp	HP Return
	Primary cooling circuit, supply temperature	CP Supply Temp	CP Supply
	Primary cooling circuit, return temperature	CP Return Temp	CP Return
	Extra temperature sensor 1	Extra Sensor Temp 1	Ext.sensor1
	Extra temperature sensor 2	Extra Sensor Temp 2	Ext.sensor2
	Extra temperature sensor 3	Extra Sensor Temp 3	Ext.sensor3
	Extra temperature sensor 4	Extra Sensor Temp 4	Ext.sensor4
	Extra temperature sensor 5	Extra Sensor Temp 5	Ext.sensor5
	Boiler temperature return	Boiler Return Temp	HB Return
	Boiler temperature	Boiler Supply Temp	HB Supply
	Return temperature for boiler 1	Boiler 1, return Temp	HB1 Return
	Return temperature for boiler 2	Boiler 2, return Temp	HB2 Return
	Return temperature for boiler 3	Boiler 3, return Temp	HB3 Return
	Return temperature for boiler 4	Boiler 4, return Temp	HB4 Return
	Temperature for differential thermostat function	Extra Circuit Sensor 1	Ext circS1
	Temperature for differential thermostat function	Extra Circuit Sensor 2	Ext circS2
	Input for receiving a current heat requirement from another controller (0...10 V corresponds to 0...100 degrees)	Heat demand temp	Heat demand

Digital inputs

✓	Description	CASE flexotron	Display
	Operating mode/alarm circulation pump, P1A-HS1	HS1, Pump A Indication	HS1 PumpA
	Operating mode/alarm circulation pump, P1B-HS1	HS1, Pump B Indication	HS1 PumpB
	Operating mode/alarm circulation pump, P1A-HS2	HS2, Pump A Indication	HS2 PumpA
	Operating mode/alarm circulation pump, P1B-HS2	HS2, Pump B Indication	HS2 PumpB
	Operating mode/alarm circulation pump, P1A-HS3	HS3, Pump A Indication	HS3 PumpA

Installation and terminal assignment

✓	Description	CASE flexotron	Display
	Operating mode/alarm circulation pump, P1B-HS3	HS3, Pump B Indication	HS3-PumpB
	Operating mode/alarm circulation pump, P1A-CS1	CS1, Pump A Indication	CS1-PumpA
	Operating mode/alarm circulation pump, P1B-CS1	CS1, Pump B Indication	CS1-PumpB
	Operating mode/alarm circulation pump, P1-HW1	HW1, Pump Indication	HW1-Pump
	Charge pump P1-HP1	HP1, Pump Indication	HP1-Pump
	Operating mode/alarm, frequency converter for pressure control	Frequency converter	Freq conv
	Pressure switch, expansion vessel	Expansion vessel	Exp. vessel
	External alarm	External alarm	External alarm
	External power limitation	External power limit	Ext pow limit
	Volume pulse, hot water consumption	Water pulse	Water pulse
	Energy pulse, heating consumption	Energy pulse	Energy pulse
	Volume pulse, cold water consumption 1	CW1 pulse	CW1 pulse
	Volume pulse, cold water consumption 2	CW2 pulse	CW2 pulse
	Energy pulse, electricity meter	Electric pulse	Electric pulse
	CS1 start	CS1, Start	CS1-start
	Boiler alarm	Boiler alarm	Boiler alarm
	Operating mode/alarm for boiler 1	Boiler 1 Indication	HB1-ind
	Operating mode/alarm for boiler 2	Boiler 2 Indication	HB2-ind
	Operating mode/alarm for boiler 3	Boiler 3 Indication	HB3-ind
	Operating mode/alarm for boiler 4	Boiler 4 Indication	HB4-ind
	Operating mode/alarm for boiler pump 1	Boiler 1 Pump Indication	HB1-pump
	Operating mode/alarm for boiler pump 2	Boiler 2 Pump Indication	HB2-pump
	Operating mode/alarm for boiler pump 3	Boiler 3 Pump Indication	HB3-pump
	Operating mode/alarm for boiler pump 4	Boiler 4 Pump Indication	HB4-pump
	Operating mode/alarm for transport pump	Transport Pump Indication	Transp pump
	External stop for boiler control	External Stop Boiler 1-4	External stop
	Pressure/flow alarm for boiler circuit	Boiler pressure/flow error	HB pres/flow

Installation and terminal assignment

✓	Description	CASE flexotron	Display
	Operating mode/alarm for extra control circuit (thermostat function)	Extra Circuit pump Indication	Ext circ pump
	Activate comfort mode for HS1	Extended running HS1	HS1 ext run
	Activate comfort mode for HS2	Extended running HS2	HS2 ext run
	Activate comfort mode for HS3	Extended running HS3	HS3 ext run

The universal inputs on the flexotron800 can each be configured as either analogue or digital inputs and used for any of the analogue or digital input signals described above.

Analogue outputs

✓	Description	CASE flexotron	Display
	Actuator, heating system 1, HS1	HS1, actuator	HS1 Actuator
	Actuator, heating system 2, HS2	HS2, actuator	HS2 Actuator
	Actuator, heating system 3, HS3	HS3, actuator	HS3 Actuator
	Actuator, cooling system 1, CS1	CS1, actuator	CS1 Actuator
	Actuator, domestic hot water circuit 1, HW1	HW1, actuator	HW1 Actuator
	Actuator, domestic hot water circuit 2, HW2	HW2, actuator	HW2 Actuator
	Frequency converter, pressure control	Diff pressure, valve	Pressure valve
	Split of one of the above circuits (not differential pressure)	Seq control of actuator HS1 - HP1	Seq control
	Boiler 1 vessel	Boiler 1, Modulating vessel	HB1 mod vessel
	Boiler 2 vessel	Boiler 2, Modulating vessel	HB2 mod vessel
	Boiler 3 vessel	Boiler 3, Modulating vessel	HB3 mod vessel
	Boiler 4 vessel	Boiler 4, Modulating vessel	HB4 mod vessel
	Boiler 1 return valve actuator	Boiler 1, return temp actuator	HB1 ret temp valve
	Boiler 2 return valve actuator	Boiler 2, return temp actuator	HB2 ret temp valve
	Boiler 3 return valve actuator	Boiler 3, return temp actuator	HB3 ret temp valve
	Boiler 4 return valve actuator	Boiler 4, return temp actuator	HB4 ret temp valve
	Highest setpoint for the configured circuits (0...100 degrees corresponds to 0...10 V)	Heat demand temp	Heat demand

Digital outputs

✓	Description	CASE flexotron	Display
	Start/stop pump, P1A-HS1	HS1, Pump A Start	HS1 PumpA
	Start/stop pump, P1B-HS1	HS1, Pump B Start	HS1 PumpB
	Start/stop pump, P1A-HS2	HS2, Pump A Start	HS2 PumpA
	Start/stop pump, P1B-HS2	HS2, Pump B Start	HS2 PumpB
	Start/stop pump, P1A-HS3	HS3, Pump A Start	HS3 PumpA
	Start/stop pump, P1B-HS3	HS3, Pump B Start	HS3 PumpB
	Start/stop pump, P1A, CS1	CS1, Pump A Start	CS1 PumpA
	Start/stop pump, P1B, CS1	CS1, Pump B Start	CS1 PumpB
	Start/stop pump, P1-HW1	HW1, Pump Start	HW1 Pump
	Start/stop water preparation pump, P1-HP1	HP1, Pump Start	HP1 Pump
	Start/stop frequency converter, pressure control	Frequency converter start	Freq conv
	Sum alarm A + B	Sum alarm	Sum alarm
	Sum alarm A	Sum alarm A	A-sum alarm
	Sum alarm B + C	Sum alarm B/C	B/C-sum alarm
	Extra timer output 1	Timer Channel 1	Timer1
	Extra timer output 2	Timer Channel 2	Timer2
	Extra timer output 3	Timer Channel 3	Timer3
	Extra timer output 4	Timer Channel 4	Timer4
	Extra timer output 5	Timer Channel 5	Timer5
	Increase 3-point actuator HS1	HS1, actuator increase	HS1 inc act
	Reduce 3-point actuator HS1	HS1, actuator decrease	HS1 dec act
	Increase 3-point actuator HS2	HS2, actuator increase	HS2 inc act
	Reduce 3-point actuator HS2	HS2, actuator decrease	HS2 dec act
	Increase 3-point actuator HS3	HS3, actuator increase	HS3 inc act
	Reduce 3-point actuator HS3	HS3, actuator decrease	HS3 dec act
	Increase 3-point actuator CS1	CS1, actuator increase	CS1 inc act
	Reduce 3-point actuator CS1	CS1, actuator decrease	CS1 dec act
	Increase 3-point actuator HW1	HW1, actuator increase	HW1 inc act

Installation and terminal assignment

✓	Description	CASE flexotron	Display
	Reduce 3-point actuator HW1	HW1, actuator decrease	HW1 dec act
	Increase 3-point actuator HW2	HW2, actuator increase	HW1 inc act
	Reduce 3-point actuator HW2	HW2, actuator decrease	HW2 dec act
	Bypass valve, CS1	CS1, Bypass Valve	CS1 bypass valve
	CS1, start cooling unit	CS1, Cool unit start	CS1 Cooling unit
	Start/stop vessel 1	Boiler 1, vessel	HB1-start1
	Start/stop vessel 1 high power	Boiler 1, vessel (High effect)	HB1-start2
	Start/stop vessel 2	Boiler 2, vessel	HB2-start1
	Start/stop vessel 2 high power	Boiler 2, vessel (High effect)	HB2-start2
	Start/stop vessel 3	Boiler 3, vessel	HB3-start1
	Start/stop vessel 3 high power	Boiler 3, vessel (High effect)	HB3-start2
	Start/stop vessel 4	Boiler 4, vessel	HB4-start1
	Start/stop vessel 4 high power	Boiler 4, vessel (High effect)	HB4-start2
	Start/stop pump, boiler 1	Boiler 1, Pump Start	HB1-pump
	Start/stop pump, boiler 2	Boiler 2, Pump Start	HB2-pump
	Start/stop pump, boiler 3	Boiler 3, Pump Start	HB3-pump
	Start/stop pump, boiler 4	Boiler 4, Pump Start	HB4-pump
	Start/stop transport pump	Transport Pump, Start	Transp pump
	Start/stop pump, extra control circuit	Extra Circuit Pump	Ext circ pump

Factory setting for RDT828 terminal assignment



(See also section 3.6.1. *Terminal assignment of flexotron800*)

-	LS	Power supply 24 V AC $\pm 15\%$. 50/60 Hz or 24 V DC,
-	MM	
-		Earth conductor
43	+24 V	+24 V DC. Reference point for digital inputs DI



1	D+	RS485 Modbus (not for WEB (TCP/IP) models)
2	D-	
3	C	
4	E	

42	LS	Reference point for digital outputs DO
41	DO1	Start/stop pump, P1A-HS1
40	DO2	Start/stop pump, P1B-HS1
39	DO3	Increase 3-point actuator for HS1
38	DO4	Reduce 3-point actuator for HS1
37	DO5	Start/stop pump, P1-HW1
36	DO6	Start/stop pump, P1A-HS2
35	DO7	Collective alarm

-	-	
-	-	
-	-	

34		Reference potential for analogue inputs AI
33	AI1	Outside temperature
32	AI2	Supply temperature, heating system 1
31		Reference potential for analogue inputs AI
30	AI3	Supply temperature, domestic hot water circuit 1
29	AI4	Return temperature, heating system 1

9	DI1	Operating mode/alarm for circulation pump, P1A-HS1
10	DI2	Operating mode/alarm for circulation pump, P1B-HS1
11	DI3	Operating mode/alarm for circulation pump, P1A-HS2
12	DI4	Operating mode/alarm for circulation pump, P1-HW1
13	DI5	Volume pulse, hot water consumption
14	DI6	Energy pulse, heating consumption
15	DI7	Volume pulse, cold water consumption 1
16	DI8	Expansion tank

28		Reference potential for universal inputs UI
27	UI1	Supply temperature, heating system 2
26	UI2	Return temperature, heating system 2
25		Reference potential for universal inputs UI
24	UI3	Room temperature, heating system 1
23	UI4	Room temperature, heating system 2

17		Reference potential for analogue outputs AO
18	AO1	Actuator, heating system 1, HS1
19	AO2	Actuator, domestic hot water circuit 1, HW1
20	AO3	Actuator, heating system 2, HS2
21	AO4	Not used
22	AO5	Not used

Installation and terminal assignment

Factory setting for RDT815 terminal assignment



 (See also section 3.6.1. *Terminal assignment of flexotron800*)

	LS	Power supply 24 V AC $\pm 15\%$. 50/60 Hz or 24 V DC
	MM	
		Earth conductor
43	+24V	+24 V DC. Reference point for digital inputs DI

1	D+	RS485 Modbus (not for WEB (TCP/IP) models)
2	D-	
3	C	
4	E	

42	LS	Reference point for digital outputs DO
41	DO1	Start/stop pump, P1A-HS1
40	DO2	Start/stop pump, P1B-HS1
39	DO3	Start/stop pump, P1-HW1
38	DO4	Collective alarm

-	-	
-	-	
-	-	



34		Reference potential for analogue inputs AI
33	AI1	Outside temperature
32	AI2	Supply temperature, heating system 1
31		Reference potential for analogue inputs AI
30	AI3	Supply temperature, domestic hot water circuit 1
29	AI4	Return temperature, heating system 1

9	DI1	Operating mode/alarm for circulation pump, P1A-HS1
10	DI2	Operating mode/alarm for circulation pump, P1B-HS1
11	DI3	Operating mode/alarm for circulation pump, P1-HW1
12	DI4	Expansion tank

17		Reference potential for analogue outputs AO
18	AO1	Actuator, heating system 1, HS1
19	AO2	Actuator, domestic hot water circuit 1, HW1
20	AO3	Not used

Factory setting for RDT808 terminal assignment

(See also section 3.6.1. *Terminal assignment of flexotron800*)

	LS	Power supply 24 V AC $\pm 15\%$. 50/60 Hz or 24 V DC	1	D+	RS485 Modbus (not for WEB (TCP/IP) models)
	MM		2	D-	
		Earth conductor	3	C	
43	+24V	+24 V DC. Reference point for digital inputs DI	4	E	
42	LS	Reference point for digital outputs DO	-		
41	DO1	Start/stop pump, P1A-HS1	-		
40	DO2	Start/stop pump, P1B-HS1	-		
34		Reference potential for analogue inputs AI	9	DI1	Operating mode/alarm for circulation pump, P1A-HS1
33	AI1	Outside temperature	10	DI2	Operating mode/alarm for circulation pump, P1B-HS1
32	AI2	Supply temperature, heating system 1	11	DI3	Not used
			17		Reference potential for analogue outputs AO
			18	AO1	Actuator, heating system 1, HS1

Installation and terminal assignment



Blank wiring diagram for RDT828

-	LS	Power supply 24 V AC $\pm 15\%$. 50/60 Hz or 24 V DC,
-	MM	
-		Earth conductor
43	+24 V	+24 V DC. Reference point for digital inputs DI



1	D+	RS485 Modbus (not for WEB (TCP/IP) models)
2	D-	
3	C	
4	E	

42	LS	
41	DO1	
40	DO2	
39	DO3	
38	DO4	
37	DO5	
36	DO6	
35	DO7	

-	-	
-	-	
-	-	

34		Reference potential for analogue inputs AI
33	AI1	
32	AI2	
31		Reference potential for analogue inputs AI
30	AI3	
29	AI4	

9	DI1	
10	DI2	
11	DI3	
12	DI4	
13	DI5	
14	DI6	
15	DI7	
16	DI8	

28		Reference potential for universal inputs UI
27	UI1	
26	UI2	
25		Reference potential for universal inputs UI
24	UI3	
23	UI4	

17		Reference potential for analogue outputs AO
18	AO1	
19	AO2	
20	AO3	
21	AO4	
22	AO5	

Blank wiring diagram for RDT815

	LS	Power supply 24 V AC ±15%. 50/60 Hz or 24 V DC
	MM	
		Earth conductor
43	+24V	+24 V DC. Reference point for digital inputs DI

1	D+	RS485 Modbus (not for WEB (TCP/IP) models)
2	D-	
3	C	
4	E	

42	LS	Reference point for digital outputs DO
41	DO1	
40	DO2	
39	DO3	
38	DO4	

-	-	
-	-	
-	-	

34		Reference potential for analogue inputs AI
33	AI1	
32	AI2	
31		Reference potential for analogue inputs AI
30	AI3	
29	AI4	

9	DI1	
10	DI2	
11	DI3	
12	DI4	

17		Reference potential for analogue outputs AO
18	AO1	
19	AO2	
20	AO3	

Blank wiring diagram for RDT808

	LS	Power supply 24 V AC ±15%. 50/60 Hz or 24 V DC
	MM	
		Earth conductor
43	+24V	+24 V DC. Reference point for digital inputs DI

1	D+	RS485 Modbus (not for WEB (TCP/IP) models)
2	D-	
3	C	
4	E	

42	LS	Reference point for digital outputs DO
41	DO1	
40	DO2	

-		
-		
-		

34		Reference potential for analogue inputs AI
33	AI1	
32	AI2	

9	DI1	
10	DI2	
11	DI3	

17		Reference potential for analogue outputs AO
18	AO1	

5 Commissioning

5.1 General information

The flexotron800 controller must be configured before use. The inputs and outputs must be assigned and all important parameters must be set.

All commissioning can be done either using the flexotron800 controller display or an external RDB800 display unit.

CASE flexotron

However, the best method is to configure the controller using CASE flexotron. CASE flexotron is a PC configuration program specially developed to simplify commissioning of the flexotron800 series.

Using CASE flexotron, the entire configuration and all settings can be prepared on the computer and then loaded to the controller. Any number of configurations can be saved on the computer for later use.

A communication cable is required in order to configure flexotron800 with CASE flexotron.

Before it is configured, the flexotron800 controller must be connected to the power supply and the application program selected.

5.2 Step-by-step

For configuration using CASE flexotron, see the CASE flexotron manual.

For configuration using the controller display there are two options, depending on the user's skill.

Option 1:

1. Go straight to sections 7 and 8, *Display, LEDs and buttons* and *Access rights*.
2. Once you are familiar with the buttons and menu system, connect the controller to the power supply. Log in as administrator and go to the "Configuration" menu.
3. For the time being, skip the configuration menu for the inputs and outputs and start by configuring the control functions.
4. Go through the configuration menu in order and set all the required functions and parameters. Section 6 *Functions* can be used as a reference. The list of input and output functions in section 4.2.3 *List of inputs and outputs* helps you keep track of the required inputs and outputs.
5. Configure the inputs and outputs.

6. Exit the “Configuration” menu and continue by making the settings within the activated controller systems.
 7. Set the control parameters in “Temperature control”.
 8. Set the running times in the “ECO/Comf.” menu.
- ➔ The flexotron800 controller is ready for operation.

Option 2:

Read this manual in the order given below: The manual provides a step-by-step guide to commissioning. The last sections of the manual describe menus and functions that are not required during commissioning. For this reason, they are not included in the following sections.

Functions

First read section 6 *Functions*. Some functions are essential for the controller to operate correctly and must be set. Others are additional functions and do not necessarily need to be set.

Section 4.2.3 *List of the inputs and outputs* contains a list of all analogue and digital inputs and outputs. Mark all the inputs and outputs in the list that you will be using for the application. Remember that the universal inputs on the RDT828 can each be configured as either analogue or digital.

Display, buttons and LEDs

Section 7 describes how to use the controller buttons to navigate the flexotron800 menu system.

Access rights

Section 8 *Access rights*, login to flexotron800.

Configuration

Section 9 *Configuration*.

Connect the power supply to the controller. Use the buttons and menu system to select the required functions in the configuration menu.

The unit is delivered preconfigured and all the inputs and outputs are assigned specific functions, which you can change later. Section 4 *Installation and terminal assignment* contains two terminal assignment diagrams, one with the preconfigured inputs and outputs and an empty one for customised configurations.

Settings

Set the controller parameters, P-band and I-time for temperature control. These settings can be found in the temperature control menu of the controller system.

To set the alarm parameters, alarm levels and alarm delays, see section 9.1 *Alarm settings*.

Time settings

See section 10.5:

Setting the clock and calendar functions.

Setpoints

See section 10.1:

Entering the setpoints for all active control loops.

Manual/automatic

See section 10.3:

Description of manual operating mode. This is useful for testing the system.

Other functions

See section 12.1: Alarm handling etc.

6 Functions

6.1 Heating control

6.1.1 General information

The flexotron800 can be configured for 1 to 3 heating systems: HS1, HS2 and HS3.

6.1.2 Controllers

The heating systems are controlled using PI controllers with an adjustable P-band and I-time.

6.1.3 Control characteristics

The controllers have individual control characteristics for the relationship between the supply temperature and the outside temperature.

Each characteristic has 8 schedule start points. The factory settings are the outside temperature values -20, -15, -10, -5, ± 0 , +5, +10, +15. These outside temperature values cannot be changed using the buttons on the flexotron800, but only using CASE flexotron. The corresponding supply temperatures, however, can be set both on the flexotron800 and using CASE flexotron.

6.1.4 Adjusting the characteristics

Room temperature sensors can be used to correct the set control characteristics. The average temperature over a defined period of time is calculated. After this, a parallel shift of the entire curve upwards or downwards is carried out, depending on whether the difference between the room setpoint and the actual room value is positive or negative. After comparison, the deviation is multiplied by the correction factor and the sum is added to the current shift according to the following formula:

$$\text{Shift} = (\text{room setpoint} - \text{average temp}) * \text{factor} + \text{current shift}$$

You can set how often this calculation takes place (0...24 h), as well as the correction factor (0...100). The shift is limited to a maximum of ± 20 degrees.

6.1.5 Temperature limit values

The heating systems have individually adjustable minimum and maximum temperature limits for the supply and return. If the return temperature is not within the set limits, the supply temperature is adjusted by a configurable factor to eliminate the error. The supply setpoint may never be above or below the set minimum or maximum supply setpoint.

The minimum limit is calculated as follows:

$$\text{Supply shift} = (\text{minimum limit} - \text{return temp}) * \text{limiting factor}$$

- i** The minimum limit can only result in a positive shift, otherwise the shift = 0.

The maximum limit is calculated as follows:

$$\text{Supply shift} = (\text{maximum limit} - \text{return temp}) * \text{limiting factor}$$

- i** The maximum limit can only result in a negative shift, otherwise the shift = 0.

Primary and secondary return temperature limit values

The primary return temperature may not be more than 3 degrees (adjustable) higher than the secondary return temperature. If the difference exceeds the set value, the valve control signal is overridden in order to close the valve and thus reduce the flow. This lowers the return temperature.

Inputs and outputs

AI	Return temperature of HS1 and/or HS2
AI	Primary heating return temperature

6.1.6 Priority of heating over hot water

It is possible to give the heating circuits priority over the hot water circuits by activating the corresponding function. If one of the heating circuits is a certain (adjustable) number of degrees below the setpoint for an adjustable period of time, the actuators of the hot water circuits are forced to close.

6.1.7 Pump control

Each circuit can be equipped with single or twin pumps. With twin pumps, only one of the pumps is operated at a time. They automatically switch over once a week. If the active pump fails, the inactive pump is automatically started up.

Pumps can be configured to stop according to the outside temperature, and individual pump start and stop delays can be configured.

The pumps are moved for 5 minutes every day at 3 p.m.

6.1.8 Frost-protection facility

If a controller is in Off or Manual mode and the outside temperature falls below a set value, an adjustable minimum supply temperature is maintained and the pump starts up.

6.1.9 Wind compensation

In order to compensate for cooling due to wind, a wind sensor can be connected and a wind-based setpoint shift can be generated. The function provides an adjustable shift factor (°C per m/s).

6.1.10 Building inertia and boost

The building inertia in relation to the heat storage capacity of the building envelope can be set in hours (0-24).

The set inertia is used to control the effect of the outside temperature on the control characteristics.

The outside temperature used to calculate the current supply temperature is an average over the set time period. If the current outside temperature is to be used, the period must be set to 0. For the daily average, set the period to 24.

Boost: At low outside temperatures, it is possible to temporarily shift the control characteristic when changing from the night-time temperature to the comfort temperature. This speeds up heating to the daytime temperature. The following conditions apply:

- The daily average outside temperature is less than 17 °C.
- The supply temperature must be above 25 °C.
- The night reduction must be more than 2 °C.

If these conditions are met, the starting time delay is calculated as follows:

$$\text{Shift} = \text{factor} * (17 - \text{outside temp}) * \text{night reduction}$$

The factor can be set from 0...10. 0 means no start delay and 10 is the maximum shift.

The running time in minutes for the shift is calculated as follows:

$$\text{Running time} = 1.6 * (17 - \text{outside temp})$$

The running time is limited to a maximum of 60 minutes.

Functions

6.1.11 Night reduction

The night reduction is set using the room temperature. To calculate the reduction of the supply temperature, the set room temperature is multiplied by 3. The flexotron800 has individual time programmes for each heating system with two comfort periods per day.

The “Extended operation HS1–HS3” digital inputs can be used to activate the comfort mode during the night set-back mode. The inputs have adjustable time delays.

6.1.12 Starting time optimisation

This function is used to achieve the required room temperature if the comfort period is activated after a night reduction. How early the supply temperature is increased is calculated as follows:

$$\text{Optimisation time} = (\text{room setpoint} - \text{room actual value}) / \text{heating capacity}$$

The heating capacity has a minimum and a maximum value (preset minimum value: 0.02 °C/min, maximum value: 0.1 °C/min). The start value for the function is the mean value of the minimum and maximum capacity. The capacity value is thus calculated as follows:

$$\text{Heating capacity} = (\text{heating capacity} + \text{temperature increase} / \text{optimisation time}) / 2$$

The temperature boost corresponds here to the difference in room temperature between the time when optimisation was stopped and the time when it was started.

Weather-dependent start time optimisation

If weather-dependent start time optimisation is activated, the compensated capacity is calculated as follows:

$$\text{Weather-dependent capacity} = \text{capacity} * (1 + \text{weather compensation} / 100 * \text{outer temp diff})$$

The weather compensation is an adjustable percentage between 0...100% (0%= no weather compensation). The default setting is 3%.

The outside temperature difference is the difference between the current outside temperature and the outside temperature at the last optimisation.

Inputs and outputs

AI	Room-temperature sensor
-----------	-------------------------

6.1.13 Power limitation

The digital input signal “External power limitation” can be used to temporarily limit the power available to the heating circuits. When the input closes, the setpoint is lowered by an adjustable factor (in relation to 20 °C). The limitation affects all configured heating systems.

The limitation is calculated as follows:

$$\text{Limited setpoint} = 20 + (\text{setpoint} - 20) * \text{factor} / 100$$

Factor 100 means no setpoint reduction, 0 means complete reduction to 20 °C.

6.2 Cooling system

6.2.1 General information

A cooling system can be configured using the controller. The setpoint for the cooling system can be fixed or weather-dependent.

6.2.2 Controllers

The cooling system is controlled using a PI controller with an adjustable P-band and I-time. The controller uses a temperature sensor input for the supply temperature of the cooling circuit and an analogue output for the cooling control valve.

6.2.3 Dew point control

Dew point control is designed to prevent condensation in the cooling pipe system when cooling convectors are connected. This function increases the supply temperature of the cooling circuit according to the current dew point in the room. A combined humidity and temperature sensor (such as an EGH111 from SAUTER) is connected and configured for this.

The dew point function calculates the current dew point temperature and adds it to an adjustable setpoint shift (default setting 1 °C). The total is then compared to the current setpoint. The higher value is then used as a setpoint for the cooling system supply temperature.

6.2.4 Pump control

A digital output can be used in the cooling system to control the pump. The pump can be configured either for continuous operation or with pump stops. The pump stops are activated via the outside temperature sensor. It is also possible to set up pump stop and start delay times. Alternatively, the digital input “CS1 start” can be used to start and stop the pump. When the pump is stopped, an output signal of 0V is present at the actuator.

Functions

6.2.5 Starting the cooling unit

A digital output can be configured for starting and stopping the cooling unit. The output is subject to the pump settings. However, pump test operation does not affect this output.

6.2.6 Eco/comfort function

The flexotron800 has a time programme for the cooling system with two comfort periods per day. Outside the comfort periods the (adjustable) supply setpoint is increased in order to reduce energy consumption.

6.2.7 Temperature limiter

The supply temperature can be assigned a value as a fixed upper limit. It is also possible to set upper and lower limits for the return temperature. If the return temperature falls below the minimum value or exceeds the maximum value, the supply setpoint is regulated using an adjustable factor.

6.2.8 Bypass valve (frost protection in the primary cooling system)

A digital output can be used in the cooling system to control a bypass valve. The CS1 bypass valve opens on the condition that the outside temperature falls below 3 °C and the CS1 valve is closed

(0%). If this condition is not met, the CS1 bypass valve remains closed.

6.3 Domestic hot water

6.3.1 General information

The flexotron800 can be configured for either one or two domestic hot water circuits, HW1 and HW2. These are regulated using a constant supply temperature.

6.3.2 Controllers

The domestic hot water systems are controlled using PID controllers with an adjustable P-band, I-time and D-time.

6.3.3 Night reduction

The flexotron800 has individual time programmes for each domestic hot water circuit with two normal temperature periods per day.

6.3.4 Pump control (HW1 only)

The flexotron800 has a digital output signal which can be used to control the circulation pump in HW1. The pump function is controlled using a time programme for the hot water circuit. It operates when the program is in a normal temperature period and stops during the night reduction.

6.3.5 Anti-legionellae function (HW1 only)

To prevent the risk of legionella bacteria, the “anti-legionellae function” can be activated. This heating can take place once a day or once a week. The running time and the start time are adjustable. If there is a return temperature sensor, the function is stopped when the return temperature exceeds 62 °C. The minimum running time is 1 minute.

6.3.6 Priority of hot water over heating

It is possible to give the hot water circuits priority over the heating circuits by activating the corresponding function. If one of the hot water circuits is a certain (adjustable) number of degrees below the setpoint for an adjustable period of time, the actuators of the heating circuits are forced to close.

6.4 Hot water preparation function

A hot water preparation function, HP1, can be configured.

The hot water preparation pump, P1-HP1, is started and stopped according to the supply and return temperature of the water tank. The return temperature sensor is positioned in the water tank and the supply temperature sensor is on the tank supply pipe.

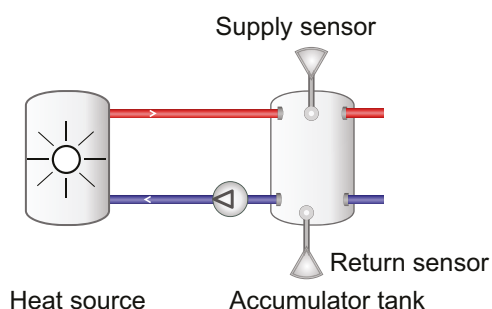

The pump starts up when the return temperature falls below the set starting temperature.

The pump switches off when the supply temperature is higher than the set cut-off temperature and the return temperature is the set difference higher than the set starting temperature.

Functions

6.4.1 Priority of HP over HS

It is possible to give HP priority over the heating circuits by activating the corresponding function (the same function as for hot water). If the HP circuit is a certain (adjustable) number of degrees below the setpoint for an adjustable period of time, the actuators of the heating circuits are forced to close.

6.5 Pressure control

The flexotron800 can use an analogue signal to control a variable-speed pump in order to maintain a constant pressure in the system.

A digital output signal is available as a start signal for the frequency converter. This signal is activated when the analogue control signal of the frequency converter exceeds 0.1 V.

6.6 Boiler control**6.6.1 General information**

The flexotron800 can be configured to control up to 4 boilers. The burners for each boiler can be set to 1-step, 2-step or modulating regulation, depending on the type of boiler control. The burners are controlled either by a PI controller with adjustable P-band and I-time, or by a thermostat function.

6.6.2 Type of boiler control

Boiler control can be configured as “OFF/ON”, as “OFF/ON/modulating control” or “Modulating control”.

OFF/ON control

In this case, the burners are controlled using a thermostat function. The burners for each boiler can be configured as 1-step or 2-step burners with adjustable hysteresis (starting point 1 (SD1) or starting point 2 (SD2)) and an offset for step 2 (high power).

Starting and stopping take place using the following formulas, as illustrated:

```
Start low power = SW - SD1  
Start high power = SW - SD2 - offset  
Stop low power = SW  
Stop high power = SW - offset
```

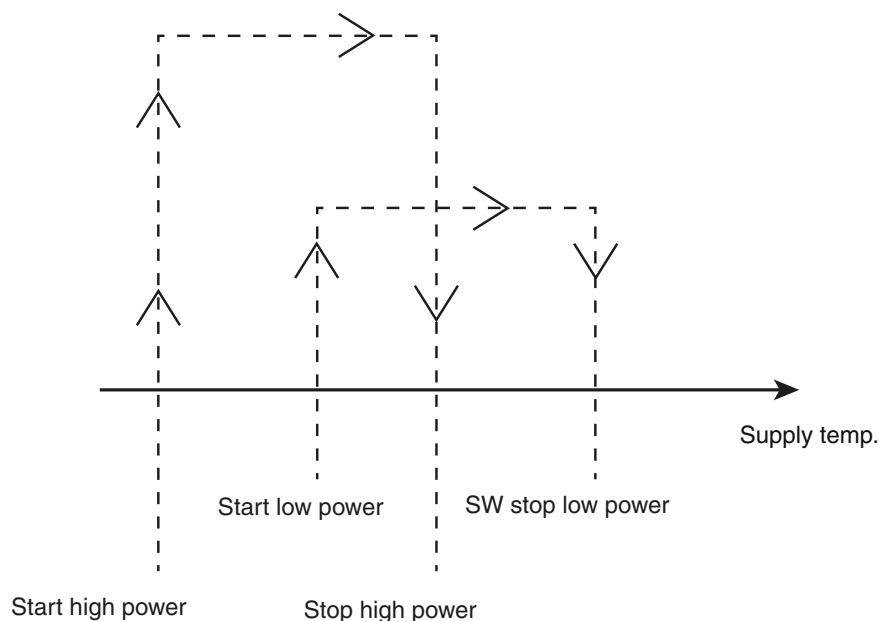
OFF/ON/modulating control

If the boiler is set to “OFF/ON/modulating control”, the boilers are regulated using a PI controller with adjustable P-band and I-time.

- The first boiler can be set to either modulating (0...10 V), OFF/ON (1-step) or OFF/ON/high power (2-step).
- Boilers 2 to 4 can be either 1-step or 2-step.

If boiler 1 is configured to modulating control, when there is an increased heat requirement the analogue output is first activated with 0...10V. If the heat requirement increases so that the first burner is no longer sufficient, the first digital output is activated as well.

The analogue output is kept at 0 V for an adjustable period of time and the controller is blocked.

After this, the analogue output is activated at 0...10 V according to the heat requirement. When the heat requirement decreases, the function operates in reverse (see the figure below). The increase and decrease in the controller take place in increments and each time digital outputs are switched on or off, the controller is blocked for the set time.

Functions

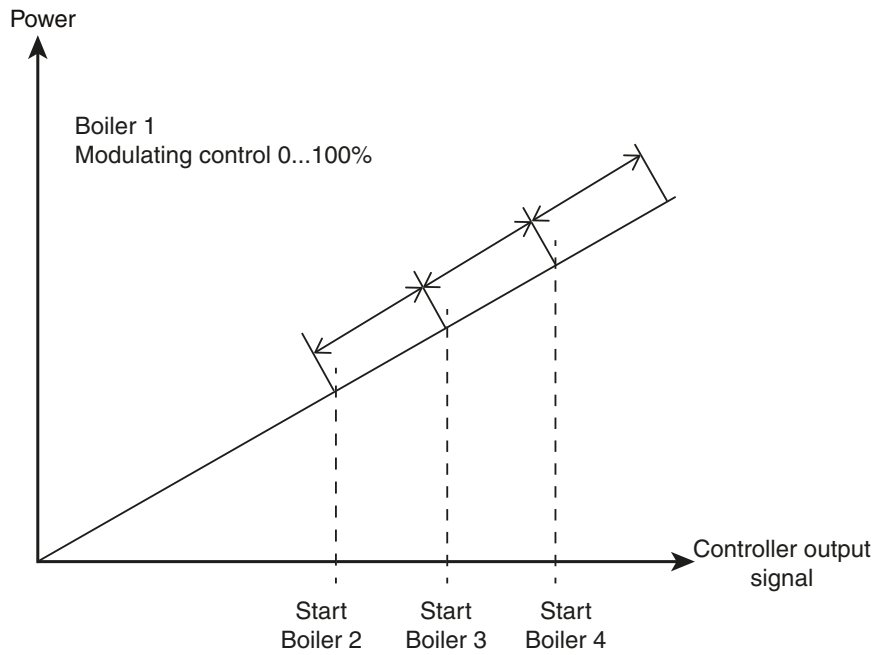

If boiler 1 is configured for the digital function (1-step or 2-step), the digital outputs are activated sequentially and every time they are switched on or off, the controller is blocked for the set time (see the figure below).

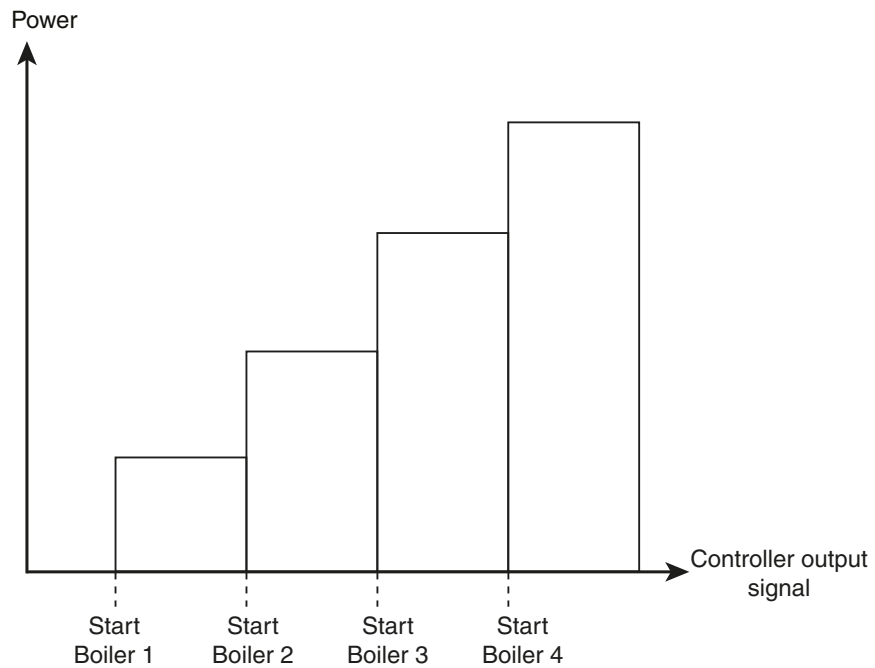

Modulating control

In this case the burners can only be configured as modulating burners (0...10 V). The burners are controlled using a PI controller with adjustable P-band and I-time. If there is a heat requirement, the burners are regulated sequentially at 0...10 V and each time they are switched on or off, the controller is blocked for the set time (see the figure below).

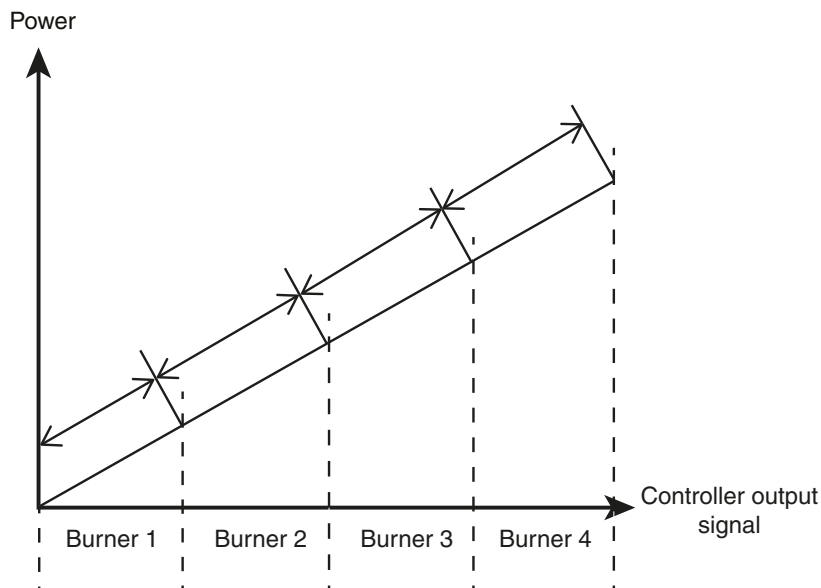

6.6.3 Setpoint

The setpoint for boiler control can be configured with one of the following alternatives:

- Constant setpoint = adjustable fixed setpoint
- Control loop setpoint

The control loop setpoint can be configured with one of the following alternatives:

- HS-dependent
- HS- and HW-dependent
- HS- and HP-dependent
- HS-, HW- and HP-dependent

When configuring a control loop setpoint, the boiler control setpoint depends on the setpoints for the other circuits. The highest of the setpoints for the other circuits, plus an offset (preset to 5 degrees), then becomes the boiler setpoint.

Weather-dependent setpoint = the setpoint varies according to the outside temperature

6.6.4 Minimum running time and stop time

The minimum running time and stop time can be individually set for each boiler. If the heat requirement increases, the next boiler cannot start until the previous boiler has been running for a set minimum time. If the heat requirement decreases, a boiler is not switched off until it has been running for a set minimum time. A boiler that has been stopped cannot start up again until it has been switched off for the set stop time.

The two values are preset to 180 seconds for all boilers.

6.6.5 Starting sequence

The starting sequence of the boilers can be individually set.

- Fixed starting sequence: The boilers always start in the same sequence: Defined first boiler, defined second boiler, defined third boiler and defined fourth boiler.
- According to operating time: The boilers start successively in order of the shortest operating time.
- Alternating: The starting sequence of the boilers is changed once a week, or every day. The time this takes place can be set. While the change is made, the starting sequence shifts by one step. In other words, the boiler which started first before the change now starts second, and so on. When the starting sequence is changed, all boilers are switched off and then start up again when there is a heat requirement.

6.6.6 Boiler test operation

The boilers can be operated for a set period on a set time and day. You can also define the number of weeks between test operations.

6.6.7 Boiler alarm

If a boiler alarm occurs, the currently active boiler is switched off. The boiler that is second in the starting sequence starts up in its place.

6.6.8 Boiler pump

Each boiler has its own circulation pump. When there is a heat requirement, the circulation pump starts up before the burner. After a period of 30 seconds (adjustable), the burner can start up. When the boiler is stopped, the burner switches off first, followed by the pump after a set delay.

The pumps are moved for 5 minutes every day at 3 p.m.

6.6.9 Transport pump

The boiler control system includes a shared transport pump. The pump starts up when a burner is operating or when the outside temperature falls below 18 °C (adjustable). If an alarm occurs on the transport pump, all the burners are stopped and disabled until the alarm is acknowledged and reset.

It is also possible to use a digital input to display the pressure and flow rate. If there is no signal when the transport pump is running, an alarm is generated and all boilers are stopped.

The pump is operated for 5 minutes every day at 3 p.m.

6.6.10 Return temperature in boiler

To minimise the risk of condensation in the boiler, it is important that the temperature is above the condensation temperature. There are two ways to ensure this:

- Uniform return temperature

The risk of condensation can be reduced by using a shared return temperature sensor. If the temperature at the sensor falls below an adjustable value (preset at 30 °C), all the valves of the HS circuits are closed. The valves remain closed as long as the boiler return temperature remains below that value + hysteresis (5 °C, adjustable).

- Individual return temperatures

Each boiler has a return temperature sensor that actuates a control valve. If the return temperature falls below an adjustable temperature (default: 40 °C), the control valve is actuated for increased recirculation. The valve is controlled using a PI controller with an adjustable P-band (10 °C).

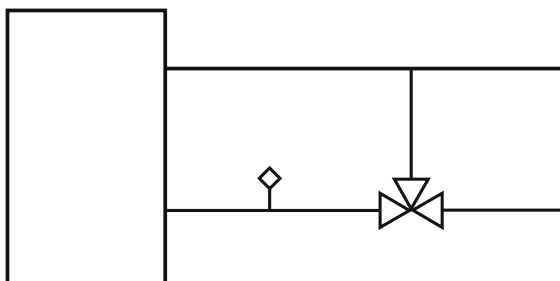

Functions

6.7 Extra control loop

This is a differential thermostat function that can be used, for example, to heat a water tank using solar panels. This function is connected to two analogue inputs (Extra control loop temp 1 and Extra control loop temp 2) and a digital output (Extra control loop pump). If Extra control loop temp 1 is a certain (adjustable) number of degrees higher (preset at 5 degrees) than Extra control loop temp 2, the pump starts up. The pump runs until Extra control loop temp 1 = Extra control loop temp 2.

6.8 Cold water consumption

Either one or two functions can be configured for monitoring cold water consumption, each with a digital pulse input for connection to a water meter. Each pulse constant can be adjusted. The maximum pulse rate is 2 Hz.

6.8.1 Values

The following values are calculated:

- Daily consumption in litres, today
- Daily consumption in litres, yesterday
- Daily consumption in litres, the day before yesterday
- Lowest hourly consumption in litres, today
- Lowest hourly consumption in litres, yesterday
- Total consumption in m³. This value can be reset.
- Water flow rate (litres/min)

6.8.2 Alarm**Pulse error**

If no pulses are received during the set time, a pulse error alarm is activated. If the time is set to 0, the alarm function is disabled.

High consumption

If the daily consumption is higher than the set value, an alarm is triggered.

Leakage

If the lowest hourly consumption on the previous day is higher than the set value, an alarm is triggered.

6.9 Energy consumption

A digital pulse function can be configured for monitoring heating energy consumption. The pulse constant can be adjusted.

6.9.1 Consumption values

The following consumption values are calculated:

- Daily consumption in kWh, today
- Daily consumption in kWh, yesterday
- Daily consumption in kWh, the day before yesterday
- Total consumption in kWh or MWh. This value can be reset.

6.9.2 Performance values

The heating performance is calculated by measuring the time between energy pulses. The following performance values are calculated:

- Instant value for a certain time span or a certain number of pulses.
- Average of the above instant values for the past hour.
- Maximum value of the above instant values.

6.9.3 Leakage monitoring

Once a week the control valves are closed and the energy consumption during a preset time is measured. If the energy leakage exceeds a preset value (default 3000 W), an alarm is triggered. The starting time and the duration of leakage monitoring are adjustable. The default setting is Sundays at 2:00 a.m. for a duration of 30 minutes.

6.9.4 Alarm

Pulse error

If no pulses are received during the set time, a pulse error alarm is activated. If the time is set to 0, the alarm function is disabled.

High consumption

If the daily consumption is higher than the set value, an alarm is triggered.

6.10 Electricity meter

A digital pulse function can be configured for monitoring heating energy consumption. The pulse constant can be adjusted.

6.10.1 Consumption values

Total consumption in MWh. This value can be reset.

6.11 Extra timer outputs

Up to five separate digital timer outputs can be configured. Each has a weekly programme with two activation periods per day. Each timer output has eight separate setting menus – one for every day of the week and an additional one for the holiday programme. The holiday programme has priority over the other programmes.

6.12 Alarm

6.12.1 Alarm handling

The alarms are indicated by the red alarm LED on the controller or on the external display.

All alarms can be monitored, acknowledged and blocked using the display and buttons.

6.12.2 Alarm priority

The alarms can be assigned different priorities: A-alarm, B-alarm, C-alarm or inactive. Digital outputs can be configured as collective outputs for A-, B- and C-alarms, for A-alarms or for B- and C-alarms. C-alarms are internal alarms which are not forwarded. A- and B-alarms must be acknowledged before they are reset. C-alarms automatically reset as soon as the cause is no longer present.

6.12.3 Alarm text

You can edit the alarm text that is displayed using CASE flexotron. For more information, see the CASE flexotron manual.

Inputs and outputs

DO	Collective alarm A-, B- & C
DO	Collective alarm A
DO	Collective alarm B/C

7 Display, LEDs and buttons



This section applies to flexotron800 controllers with display and buttons, as well as to RDB800 external displays which can be connected to flexotron800 units.

7.1 Display

The display has four rows of 20 characters each and is backlit. The lighting is normally off. It is activated as soon as a button is pressed and switched off again after a long period of inactivity.

7.2 LEDs

There are two LEDs on the front:

- The alarm LED is indicated by the  symbol.
- The “Edit mode” LED is indicated by the  symbol.

The four LEDs beside the upper terminal strip will be described later.

7.3 Buttons

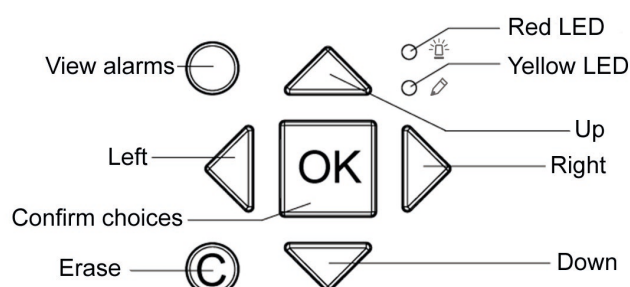

The flexotron800 has 7 buttons. Four of them are arrow buttons: [Up], [Down], [Right] and [Left]. The menus in the flexotron800 are organised in a horizontal tree structure. Use the [Up] and [Down] buttons to move between menus at the present menu level. Use the [Right] and [Left] buttons to move between menu levels. When changing parameters, use the [Up] and [Down] buttons to increase or decrease the parameter value and the [Right] and [Left] buttons to move between the digits within the parameter.

- Use the [OK] button to confirm the parameter setting. For more information see the “Editing parameters” section below.
- Use the [C] button to cancel an entered parameter change and restore the original value.
- To see the alarm list, use the red [ALARM] button.

7.4 Menu navigation

The menus which appear depend on your access level.

The start display, which is normally shown, is at the root of the menu tree.

```
Heating controller
 2010-01-01 00:00
HS1
Sp: 52.0 Act: 52.5
```

Press the [Down] button to go to the menus at the lowest level. Press the [Up] button to go back to the selection.

Depending on your access level, various menus are displayed (see section 8 for more information on logging into a higher access level). When using the normal access level, which does not normally require a login, only a few basic menus are displayed:

```
HS1
HS2
HW1
Time / Extra timers
Holiday
Energy/Cold water
Running mode
Access Rights
```

Use the [Up] or [Down] button to enter a higher menu level. Press the [Right] button to confirm. On each level there may be more new menus, which you can view using the [Up] and [Down] buttons.

Sometimes there are further submenus linked to a menu or menu item. Additional menus are indicated by an arrow symbol in the right corner of the display. Use the [Right] button again to select them. Use the [Left] button to go back one menu level.

Editing parameters

Some menus contain parameters that can be set. This option is indicated by the flashing yellow LED  .

Rapid flashing (twice per second) indicates that the parameter can be edited using the current access level. If the LED flashes more slowly (once per second), a higher access level is required to edit the parameter.

To edit a parameter, first press the [OK] button. If you need a higher access level to edit the parameter, a login menu appears - see section 8 *Access rights*. Otherwise, the cursor appears next to the editable values. Press the [Up] and [Down] buttons to edit the value.

In numbers containing several digits you can move between the digits using the [Left] and [Right] buttons.

When the required value is displayed, press [OK].

If there are other editable values, the cursor automatically moves to the next one.

To skip a value without editing it, press the [Right] button.

To reverse a change, press and hold the [C] button until the cursor disappears.

8 Access rights

There are four different access levels, including Admin, which has the highest access rights, Operator, and the Basic access level which does not require a login. The access level determines which menus and editable parameters are displayed.

Admin level gives full read/write access to all settings and parameters in all menus.

Service level gives access to all menus except the submenus "Configuration > Inputs and Outputs" and "Configuration > System".

Operator level gives access to all menus except "Configuration".

Basic level permits changes in the operating mode and read-only access to a limited number of menus.

To log into the various access levels, repeatedly press the [Down] button in the start display until the arrow in the left of the display points to "Access rights". Press the [Right] button.

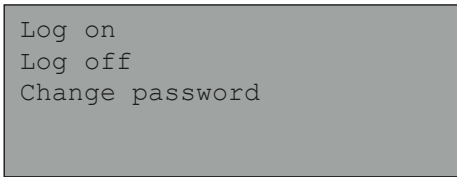

```
Log on
Log off
Change password
```

8.1 Log on

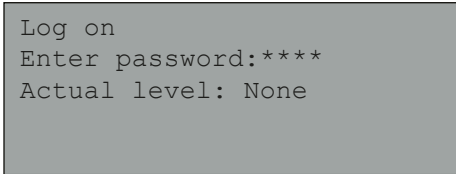

```
Log on
Enter password:****
Actual level: None
```

In this menu it is possible to log into any access level by entering the appropriate 4-digit password (code).

The menu is also displayed if you try to access a menu or carry out a function that requires a higher access level.

When you press the [OK] button, the cursor jumps to the first digit. Repeatedly press the [Up] button to set the digit. Press the [Right] button to go to the next digit. Repeat the procedure for all four digits of the code. Press [OK] to confirm. An info text with the current access level appears in the display. Use the [I] button to quit this menu.

Access rights

8.2 Log off

Use this menu to log out from the current access level to the Basic level that does not require a login.

```
Log off?
No
Actual level:Admin
```

Automatic logout

If the access level is Operator, Service or Admin, the user is automatically logged out and returned to Basic level after a period of inactivity. For more information, see section 8.2 *Logout / automatic logout*. This function can also be deactivated - see section 8.5 *Changing the password to deactivate automatic logout*.

8.3 Change code

The flexotron800 is supplied with the following default passwords for the different levels:

- Admin 1111
- Service 2222
- Operator 3333
- Basic 5555

You can only change the password for the access level you are currently in, or for lower ones. For example, if you are logged in as Admin, you can change all the passwords. If you are logged in as Operator, on the other hand, you can only change the Operator and Basic passwords. However, there is no point in changing the Basic password since access to that level is granted automatically to all users.

```
Change password
for:Operator
New password: ****
```

i The Admin password may not be the same as the password for a lower level, because this would prevent access to the Admin level.

8.4 Forgotten password

If the Admin password has been changed and then forgotten, a temporary password can be obtained from SAUTER. This is only valid for one day and must be changed within this time.

8.5 Change the password to deactivate automatic logout

If you want to deactivate the automatic logout function, change the password of the required level to 0000. This level then remains always active.



Remember that there is no alarm that indicates that a particular level is activated. However, this function can be very useful if the unit will be used by trained operators or during commissioning.

9 Configuration

Log in as Admin. See section 8 *Access rights*.

Press the [Down] button until the cursor is in front of "Configuration", then press the [Right] button.

The main configuration menu appears.

```
Alarm settings
Inputs/Outputs
Sensor settings
Supply
Return temp
Boiler control
Pump stop
Twin/Single pump
Run ind/Motor prot
Actuator type
Actuator run time
Actuator exercise
Leakage monitoring
Pulse inputs
Alarm config.
Communication
Other parameters
System
```

9.1 Alarm settings

```
Alarm limits →
Alarm delay →
```

9.1.1 Alarm limits

Control offsets for HS1, HS2 and HS3

```
Control deviation
HS1: 20.0°C
HS2: 20.0°C
HS3: 20.0°C
```

Configuration

Control offsets for CS1, HW1 and HW2

```
Control deviation
CS1: 20.0°C
HW1: 20.0°C
HW2: 20.0°C
```

Over-temperature for HW1 and HW2

```
Scalding temp.
HW1: 65.0°C
HW2: 65.0°C
```

Low return temperature

```
Low return temp
HW1: 10°C
```

Boiler temperatures

```
High boiler temp
70.0°C
Low boiler temp
30.0°C
```

High water consumption

```
High 24h water
consump: 10000.0 l
High 1h water
consump: 10000.0 l
```

High energy consumption

```
High 24h energy
consump
10000.0kWh
```

Maximum time between pulses

```
Max between Vpulse
0 min
Max between Epulse
0 min
```

```
Max between CW1pulse  
0 min  
Max between CW2pulse  
0 min
```

Maximum permitted leakage

```
Permitted leakage  
3.00 kw
```

9.1.2 Alarm delay

Control offsets for HS1, HS2 and HS3

```
Control deviation  
HS1: 60 min  
HS2: 60 min  
HS3: 60 min
```

Control offsets for CS1, HW1 and HW2

```
Control deviation  
CS1: 0 min  
HW1: 60 min  
HW2: 60 min
```

Over-temperature

```
Scalding temp.  
HW1: 300 s  
HW2: 300 s
```

Low return temperature

```
Low return temp  
HW1: 20 s
```

Configuration

Boiler temperatures

```
High boiler temp
 0 s
Low boiler temp
 0 s
```

Expansion vessel / external alarm

```
Expansion vessel
 60 s
External alarm 1
 0 s
```

9.2 Inputs and outputs

```
AI
DI
UI
AO
DO
```

9.2.1 General information

Free configuration

Any signal can be connected to any input or output, the only restriction being that digital signals cannot be connected to analogue inputs or vice versa. It is the user's responsibility to make sure that the activated functions are connected to the right inputs and outputs.

Factory setting

On delivery, signals are assigned to all the inputs and outputs. These are suggestions only and can easily be changed.

9.2.2 Analogue inputs AI

```
AI1
Signal: Outdoor temp
Raw value: 18.4
Compensation:0.0°C
```

All analogue inputs are suitable for Ni1000 or 0...10 V. Corrections can be made for input signals, for example for electrical resistance. The raw value shows the actual, uncompensated input value.

9.2.3 Digital inputs DI

```
DI1
NO/NC: NO Signal:
HS1-PumpA
Status: Off
```

To make them easier to adapt to external functions, all digital inputs can be configured either as normally open (NO) or normally closed (NC).

By default, the inputs normally open, which means if the input is closed, the function linked to the input in the flexotron800 is activated.

9.2.4 Universal inputs UI

Unlike the other models, the largest models, RDT828Fxxx, have universal inputs. These can be individually configured as either analogue or digital inputs. If an input is configured as analogue, it can be assigned any analogue signal in the “Analogue input signals” list.

If an input is configured as digital, it can be assigned any digital signal in the “Digital input signals” list.

```
UI1 →
Choose AI or DI sign
AI Sign: HS2 Supply
DI Sign: Not Active
```

Once the AI or DI signal has been specified (the unused alternative must be set to not active), submenus with settings appear. Press the [Right] button to access these menus.

```
UAI1
Sign: HS2 Supply
Raw value: 38.5
Compensation: 0.0°C
```

The input signals can be compensated, for example as regards line resistance.

The raw value is the actual, uncompensated value.

If the input is configured as digital, a submenu is available, which you can access by pressing the [Right] button:

Configuration

```
DI1  
NO/NC: NO Signal:  
HS2-PumpA  
Status: Off
```

To simplify adaptation to external functions, all universal inputs can be configured as either normally open (NO) or normally closed (NC).

By default the inputs are NO, which means that if the input is closed, the function linked to the input in the flexotron800 is activated.

9.2.5 Analogue outputs AO

Analogue outputs are suitable for 0...10 V DC.

```
AO1  
Sign: HS1 Actuator  
Auto  
Value: 2.3 V
```

Analogue outputs can be set to "Auto", "Manual" or "Off" mode.

9.2.6 Digital outputs DO

```
DO1  
Signal: HS1-PumpA  
Auto  
Status: On
```

Digital outputs can be set to "AUTO", "MANUAL ON" or "MANUAL OFF" mode.

9.3 Sensor settings

In this menu you can set the type of sensors that are connected. The room temperature sensors for HS1-HS3 and CS1 are the only temperature sensors that can be set as either Ni1000 or 0...10 V. All other temperature sensors must be Ni1000.

When Ni1000 is selected, no scaling of the input is required.

```
HS1 Room sensor  
Type:Ni-1000
```

If HS1-HS3 are set to 0...10 V, the measuring range of the sensor can be scaled.

```
HS1 Room sensor
Type:0-10V →
```

```
HS1 Room sensor
0V = 0°C
10V = 100°C
```

The heating circuits can receive the room temperature via serial communication.

```
HS1 room sensor
Type: external sensor
```

To scale the CS1 room temperature sensor input

```
Room sensor CS1
0V = 0°C
10V = 50°C
```

To scale the differential pressure input

```
Pressure at
0V: 0.0 kPa
10V: 10.0 kPa
Filter factor: 0.2
```

9.4 Supply

```
Parallel displacem
Max limit sp
Min limit sp
Auto-correct. Setp
Wind compensation
Optimizer
Power limitation
Control function
DewPoint Temp.
```

Configuration

9.4.1 Parallel displacement

The control characteristics for the supply temperatures can be individually parallel-shifted.

```

HS1: 0.0 °C
HS2: 0.0 °C
HS3: 0.0 °C
CS1: 0.0 °C
    
```

9.4.2 Maximum limitation

The maximum supply temperature can be individually set for the various systems.

```

Max limit sp
HS1: 1000 °C
HS2: 1000 °C
HS3: 1000 °C
CS1: 1000 °C
    
```

9.4.3 Minimum limitation

The minimum supply temperature can be individually set for the various systems.

```

Min lim sp
HS1: 0 °C
HS2: 0 °C
HS3: 0 °C
    
```

9.4.4 Setpoint auto-correct

Room temperature sensors can be used to correct the set control characteristics. The average temperature over a defined period of time is calculated. After this, a parallel shift of the entire curve upward or downward is carried out, depending on whether the difference between the room setpoint and the actual room value is positive or negative. After comparison, the deviation is multiplied by the correction factor and the sum is added to the current shift according to the following formula:

$$\text{Shift} = (\text{room setpoint} - \text{average temp}) * \text{factor}$$

The frequency of this calculation can be set between 0...24 h. At 0 h, a calculation is performed every minute, at 24 h the calculation takes place once a day. The correction factor can be set from 0...100. The present shift is limited to a maximum of ± 20 °C. The present room temperature must be between 10...30 °C so that the function is activated and the outside temperature must move between the X

coordinates of the weather-dependent characteristic (i.e. an outside temperature of FI 20...+15 °C).

```
Auto-correction
Setpoint HS1:
On →
```

```
Corr factor HS1
2.0
Present correction
0.6°C
```

```
Correction time
(0=direct): 1 h
```

The shorter the correction time, the lower the correction factor should be. If the correction factor is set too high in relation to the time, the present correction changes very quickly.

9.4.5 Wind compensation

The wind compensation function can be used to compensate the supply temperature setpoint according to the current measured wind speed. A wind sensor with a 0...10 V output signal can be connected to an analogue input on the flexotron800. The input signal is scalable.

```
Wind speed
Actual value: 2.3 m/s
Scale factor: 1.0 m/s/v
```

```
Wind compensation
HS1: 1.00°C/m/s
HS2: 0.00°C/m/s
HS3: 0.00°C/m/s
```

Configuration

9.4.6 Optimisation

The optimizer function is used for reaching the set comfort temperature if the comfort period is activated after an ECO increase or reduction. For more detailed information see section 6.2.6 *Eco/comfort function*.

```
Optimizer function
Min capacity
Max capacity
Outdoor comp. fact.
```

Optimisation function

Activate or deactivate the function.

```
Optimizer function
HS1: No
HS2: No
HS3: No
```

Minimum capacity

Set the minimum value of the capacity variables.

```
Min capacity
HS1: 0.02°C/min
HS2: 0.02°C/min
HS3: 0.02°C/min
```

Maximum capacity

Set the maximum value of the capacity variables.

```
Max capacity
HS1: 0.10°C/min
HS2: 0.10°C/min
HS3: 0.10°C/min
```

Weather-dependent factor

Set the effect of the outside temperature on the function.

```
Outdoor comp. fact.
HS1: 3.0 %
HS2: 3.0 %
HS3: 3.0 %
```

9.4.7 Power limitation

The power for HS1 can be restricted by connecting a district heating meter to interface 2. In this case the control valve is regulated using two PI-controllers. The controller with the lowest output signal controls the valve.

```
Power limit M-Bus  
HS1: Yes
```

9.4.8 Control function CS1

The setpoint for the cooling circuit can be either constant or outdoor compensated.

```
Control function CS1  
Constant setpoint
```

9.4.9 Dew point control

The dew point function calculates the current dew point temperature, taking the room temperature (cooling) and the relative air humidity into account. The calculated dew point temperature is added to the current setpoint offset (the default setting is 1 °C) and then compared to the current setpoint. The higher of the two values is used as the current cooling setpoint. In order not to use up all the processor capacity for calculating the dew point temperature, there is a hysteresis for the temperature (0.1 °C) and the relative air humidity (1%). This means that the current dew point temperature is updated at close intervals.

```
DewPoint function  
CS1: Not Active →
```

Submenus when dew point control is activated:

```
Max. setpoint limit  
1000.0
```

Configuration

The setpoint shift is added to the calculated dew point.

```
Parallel setpoint  
offset = 1.0
```

9.4.10 Heat demand to AO

The analogue output for heat demand is used when multiple flexotron800 units are installed in one and the same building and one of the controllers regulates a boiler. The output ranges from 0...10 V depending on the highest setpoint in the configured system, where 0 V = 0 °C and 10 V = 100 °C.

The following can be selected:

- HS setpoint
- HS and HW setpoint
- HS and HW
- HS, HW and HP

```
Heat demand temp  
HS1-3
```

9.4.11 Heat demand AI

The analogue input for heat demand can be used to receive the heat demand of another flexotron800 (AO → AI). The internal setpoint of the boiler circuit is then compared with the setpoint of the analogue input. The highest setpoint is then used as the setpoint for the boiler control.

There is no limit for the number of devices that can be connected to one and the same boiler control (AO → AI... AO → AI). The only requirement is that the boiler control unit must be located at the last position in the loop.

9.5 Return temperature limit

Individual minimum and maximum temperature limits can be set for the various temperature systems. If the return temperature is not within the set limits, the supply temperature is adjusted to eliminate the error. The correction is made at the level of the temperature error, which is multiplied by the set limitation factor.

```
Max. return temp.  
Max delta-T HP/HS  
Min. return temp.  
Return limit factor
```

9.5.1 Maximum return temperature

```
Max. return temp.  
HS1:Active →  
HS2:Not active  
HS3:Not active  
CS1:Not active
```

```
Max. return temp.  
HS1: 1000°C  
HS2: 1000°C  
HS3: 1000°C  
CS1: 1000°C
```

9.5.2 Max delta-T HP/H

The return temperature in the primary heating circuit can be limited so that the HP primary circuit is not more than 3 degrees (adjustable) higher than the return in the secondary circuit. If the function is active and the primary heating circuit exceeds the return of the secondary circuit by more than the set number of degrees, the valve closes in order to lower the return temperature.

```
Max delta-T HP/HS  
HS1:Active →  
HS2:Not active
```

```
Max delta-T HP/HS  
HS1: 3°C  
HS2: 3°C
```

Configuration

9.5.3 Minimum return temperature

```

Min. return temp.
HS1:Active →
HS2:Not active
HS3:Not active
CS1:Not active
    
```

```

Min. return temp.
HS1: 0°C
HS2: 0°C
HS3: 0°C
CS1: 0°C
    
```

9.5.4 Return limitation factor

```

Return limit factor
HS1: 1.00
HS2: 1.00
HS3: 1.00
CS1: 1.00
    
```

9.6 Boiler control

For configuring and setting boiler control.

```

General
Boiler1
Boiler2
Boiler3
Boiler4
Boiler pumps
    
```

9.6.1 General information

Set the type of boiler control. Boiler control can be configured as “OFF/ON”, as “OFF/ON/modulating control” or “Modulating control”. For more information on the various types of boiler control, see section 6.6.2 *Type of boiler control*.

```

Type of boiler
Off/On
    
```

If the boiler control is set to either “OFF/ON/modulating control” or “Modulating control”, it is possible to activate the boiler change function. The setting of each boiler is described in section 9.6 *Boiler control*.

```
Boiler Exchange
Weekday: No exchange
Hour: 10
```

The setpoint type can be set to constant setpoint, weather-dependent setpoint or control loop setpoint. See also section 6.6.3 *Setpoint*.

```
Type of setpoint
Constant setpoint
```

The number of boilers can be set from 1 to 4.

```
Number of boilers
4
```

If the shared return temperature sensor “Boiler return temp” falls below the set temperature, activation of the HS valves is disabled. It is enabled when the return temperature rises above the set temperature + 5 °C again.

```
Block valves at low boiler
return
temp: 30.0°C
Hyst: 5.0°C
```

9.6.2 Boiler 1 to 4

The boilers can have 1-step, 2-step or modulating burners.

```
Vessel1
1-step
```

Configuration

For setting the starting sequence and the admissible minimum running time and stop time. The starting sequence can be set to “Fixed boiler 1...4”, according to the operating time, or alternating. See also section 6.6.5 *Starting sequence*.

```
Start mode:
Fixed 1st boiler:
Min run time: 180 s
Min stop time: 180 s
```

With modulating burners the control signal can be 0...10 V, 2...10 V, 10...2 V or 10...0 V.

```
Vessel1
Control Signal:0-10V
```

Setting the boiler test operation.

```
Exercise:Off
No of weeks:4
Day: Sun Hour: 15
Exercise time: 5 min
```

9.6.3 Pumps

A shared transport pump and an individual pump for each boiler are available for controlling the boilers.

```
Transport pump
Boiler pump(s)
```

The shared transport pump starts and stops partially according to the outside temperature and partially according to requirements. If the outside temperature is below 18 °C, the pump operates constantly. If the outside temperature rises above 18 °C, the pump starts when there is a heat requirement, i.e. when the boiler is running.

```
Outd temp. for
start of pump: 18°C
Hyst. for start/stop
of pump: 1.0°C
```

Before a boiler can start, its circulation pump must have been running for 30 seconds. During a stop, the boiler first switches off, followed by the pump 30 seconds later.

```
Run time
before HB: 30 s
Run time after stop of
HB : 30 s
```

To set the test operation and deactivate the function, set the time to 0.

```
Pump exercise:
Hour: 15
Time: 5 min
```

9.7 Pump stop

Each heating system has individual start and stop delays. If the outside temperature exceeds the set cut-off temperature for more than the set stop delay, the circulation pump switches off and the signal at the valve actuator is set to 0. If the outside temperature falls below the set cut-off temperature for longer than the start delay by more than the set hysteresis, the pump starts again. For information on setting the hysteresis and the start and cut-off temperatures, see 10.1.1.

```
Pump stop HS1:On
Stop delay: 1 min
Start delay: 0 min
```

The cooling system also has individual start and stop delays. If the outside temperature falls below the set cut-off temperature for more than the set stop delay, the pump switches off and the signal at the valve actuator is set to 0. If the outside temperature exceeds the set start temperature for longer than the start delay by more than the set hysteresis, the pump starts again. For information on setting the hysteresis and the start and cut-off temperatures, see 10.1.1.

Alternatively to the outside temperature-dependent pump stop, the digital input "CS1 start" can be used to STOP/START the pump and for regulation. The signal at the valve actuator is set to 0 V if the input is off. When configuring "CS1 start", this input must be active so that the pump can be allowed to start and the valve can open when required.

```
Pump stop CS1:Yes
Stop delay: 1 min
Start delay: 1 min
```

Configuration

The domestic hot water system HW1 does not have a temperature-dependent pump stop function, but is based on the timer output. HW1 stops when the time is no longer in the timer channel for the comfort temperature. The pump starts again when the time is within the configured comfort period.

```
Pump stop HW1: Off
```

The daily test operation for the heating systems and the cooling system takes place at 3 p.m. (adjustable).

```
Hour for exercise
HS1: 15 h
HS2: 15 h
HS3: 15 h
```

```
Hour for exercise
CS1: 15 h
```

9.8 Twin/single pump

Each system can be configured with either a single or a twin pump.

With twin pumps, only one of the pumps operates at a time. An automatic change takes place once a week at 10:00 am on Tuesday. If the active pump fails, the inactive pump starts up automatically.

```
Twin/Single pump
HS1: Twin pumps
HS2: Single pump
HS3: Single pump
```

```
Twin/Single pump
CS1: Single pump
```

9.9 Operating mode/motor protection

Digital inputs can be used for operating mode signals or for monitoring the motor protection switches of the pumps. The inputs can be either normally open (NO) or normally closed (NC) (see section 9.2.3). If the pump is configured for operating mode, the input must be normally open. This means that the digital input must be ON when the pump is running and OFF when the pump is stopped. An alarm is generated if this is not the case with the pump in question for longer than the set alarm delay.

If the pump is configured for motor protection and the input is normally open, a pump alarm is triggered when the input is ON. If the input is configured as normally closed, a pump alarm is generated if the input is OFF.

```
Run ind/Motor prot  
HS1: Motor prot  
HS2: Motor prot  
HS3: Motor prot
```

```
Run ind/Motor prot  
CS1: Motor prot  
Ext.Circ.:Motor prot
```

```
Run ind/Motor prot  
HW1: Motor prot  
HP1: Motor prot  
Freq con: Motor prot
```

```
Boiler 1: Motor prot  
Boiler 2: Motor prot  
Boiler 3: Motor prot  
Boiler 4: Motor prot
```

```
HB pump1: Motor prot  
HB pump2: Motor prot  
HB pump3: Motor prot  
HB pump4: Motor prot
```

```
Transp pump: Motor prot
```

Configuration

9.10 Type of actuator

Select the output signals to be used for the analogue outputs of the actuators:

- 0...10 V DC
- 2...10 V DC
- 10...0 V DC or
- 10...2 V DC

```
Actuator type
HS1: 0-10V
HS2: 0-10V
HS3: 0-10V
```

```
Actuator type
CS1: 0-10V
```

```
Actuator type
HW1: 0-10V
HW2: 0-10V
Freq: 0-10V
```

i Although the manufacturers of actuators often specify 0...10 V DC as the input signal, the actual control signal on many actuators is 2...10 V DC. Read the operating manual of the actuator carefully. If you are not sure, select 0...10 V DC. Regulation may be less precise in some circumstances, but you can be sure that the valve can always be moved to its end positions.

9.11 Actuator run time, 3-point actuators

These parameters have no function if analogue actuators are configured.

The values are used to define the control parameters for 3-point actuators.

These values must be correctly set, as otherwise the control will be imprecise.

```
Actuator run time
HS1: 120 s
HS2: 120 s
HS3: 120 s
```

```
Actuator run time
CS1: 120 s
HW1: 80 s
HW2: 80 s
```

9.12 Anti-jamming function

The valves and actuators for the cooling and heating systems can be operated daily as a test. The factory-set time for this is 2:00 a.m., but this can be changed to any other time. The actuators are opened for the set time (15 seconds by default, but this can be changed using CASE flexotron). During the test run, the pumps operate and the temperature deviation alarm is disabled.

```
Actuator exercise
HS1: Off time:15 s
Day: Every day
Hour:2 Min.: 0
```

```
Actuator exercise
CS1: Off time:15 s
Day: Every day
Hour:2 Min.: 0
```

9.13 Leakage monitoring

Once a week the control valves are closed and the energy consumption during a preset time is measured. If the energy leakage exceeds a preset value (default 3000 W), an alarm is triggered. The starting time and the duration of leakage monitoring are adjustable. The default setting is Sundays at 2:00 a.m. for a duration of 30 minutes.

```
Leakage mon.:Off
Weekday:Sunday
Hour: 2
Duration: 30 min
```

```
Permitted leakage
3.00 kW
Start monitoring now
No
```

Configuration

9.14 Pulse inputs

```
Energy pulse heating
100.0 kWh/pulse
Volume pulse heating
10.0 l/pulse
```

```
Cold water 1
10.0 l/pulse
Cold water 2
10.0 l/pulse
```

```
Electricity meter
100.0 kWh/pulse
```

9.15 Alarm configuration

This function allows you to configure all alarms.

Select the appropriate alarm number from the alarm list. The alarm text for that alarm is displayed and the alarm priority can be set: A-alarm, B-alarm, C-alarm or inactive.

```
Alarm no. (1-146): 1
Malfunction P1A-HS1
→
```

```
Malfunction P1A-HS1
Alarm class:B-alarm
```

Alarm text

You can change the alarm text that is displayed using CASE flexotron. For more information, see the CASE flexotron manual.

Alarm list

The alarm text and priority column show the factory settings.

	Alarm text	Prio	Description
1	Malfunction P1A-HS1	B	Malfunction on pump P1A-HS1
2	Malfunction P1B-HS1	B	Malfunction on pump P1B-HS1
3	Malfunction P1A-HS2	B	Malfunction on pump P1A-HS2
4	Malfunction P1B-HS2	B	Malfunction on pump P1B-HS2
5	Malfunction P1A-HS3	B	Malfunction on pump P1A-HS3
6	Malfunction P1B-HS3	B	Malfunction on pump P1B-HS3
7	Malfunction P1-HW1	B	Malfunction on pump P1-HW1
8	Malfunction P1-HP1	B	Malfunction on pump P1-HP1
9	Malfunction on frequency converter	B	Malfunction on converter
10	Expansion vessel	A	Expansion vessel
11	External alarm	A	External alarm
12	Boiler alarm	A	Boiler alarm
13	Deviation HS1	A	Supply temperature HS1 deviates too much and too long from the setpoint
14	Deviation HS2	A	Supply temperature HS2 deviates too much and too long from the setpoint
15	Deviation HS3	A	Supply temperature HS3 deviates too much and too long from the setpoint
16	Deviation HW1	A	Supply temperature HW1 deviates too much and too long from the setpoint
17	Deviation HW2	A	Supply temperature HW2 deviates too much and too long from the setpoint
18	Sensor error Outdoor temp	B	Sensor error Outdoor temp
19	High HW1 temp.	B	HW1 supply temperature too high
20	High HW2 temp.	B	HW2 supply temperature too high
21	High Boiler temp.	A	Boiler temperature too high
22	Low Boiler temp.	A	Boiler temperature too low
23	Pulse error volume	B	No pulses from the water volume meter
24	Pulse error energy	B	No pulses from the energy meter
25	High cold water usage/day	B	Daily cold water consumption above the set limit
26	High energy usage	B	Daily energy consumption above the set limit
27	High cold water usage/hour	B	Cold water consumption above the set limit
28	High leakage	B	Leakage above the set limit

Configuration

	Alarm text	Prio	Description
29	Malfunction P1A&B-HS1	A	Malfunction on both circulation pumps P1A and P1B in HS1
30	Malfunction P1A&B-HS2	A	Malfunction on both circulation pumps P1A and P1B in HS2
31	Malfunction P1A&B-HS3	A	Malfunction on both circulation pumps P1A and P1B in HS3
32	Pulse error CW1	B	No pulses from cold water meter 1
33	Pulse error CW2	B	No pulses from cold water meter 2
34	HS1 manual	C	HS1 in manual mode
35	HS2 manual	C	HS2 in manual mode
36	HS3 manual	C	HS3 in manual mode
37	HW1 manual	C	HW1 in manual mode
38	HW2 manual	C	HW2 in manual mode
39	Pressure control manual	C	Pressure control in manual mode
40	Boiler manual	C	Boiler in manual mode
41	P1A-HS1 manual	C	P1A-HS1 in manual mode
42	P1B-HS1 manual	C	P1B-HS1 in manual mode
43	P1A-HS2 manual	C	P1A-HS2 in manual mode
44	P1B-HS2 manual	C	P1B-HS2 in manual mode
45	P1A-HS3 manual	C	P1A-HS3 in manual mode
46	P1B-HS3 manual	C	P1B-HS3 in manual mode
47	P1-HW1 manual	C	P1-HW1 in manual mode
48	P1-HP1 manual	C	P1-HP1 in manual mode
49	P1-Freq. manual	C	P1 frequency controlled in manual mode
50	HS1 Supply Max	-	HS1 maximum supply limit activated
51	HS2 Supply Max	-	HS2 maximum supply limit activated
52	HS3 Supply Max	-	HS3 maximum supply limit activated
53	HS1 Supply Min	-	HS1 minimum supply limit activated
54	HS2 Supply Min	-	HS2 minimum supply limit activated
55	HS3 Supply Min	-	HS3 minimum supply limit activated
56	HS1 Return Max	-	HS1 maximum return temperature limit activated
57	HS2 Return Max	-	HS2 maximum return temperature limit activated

	Alarm text	Prio	Description
58	HS3 Return Max	-	HS3 maximum return temperature limit activated
59	HS1 Return Min	-	HS1 minimum return temperature limit activated
60	HS2 Return Min	-	HS2 minimum return temperature limit activated
61	HS3 Return Min	-	HS3 minimum return temperature limit activated
62	HS1 Frost	B	HS1 frost protection activated
63	HS2 Frost	B	HS2 frost protection activated
64	HS3 Frost	B	HS3 frost protection activated
65	Internal battery error	B	Error on the internal backup battery
66	Low Boiler return temp.	C	Boiler return temperature too low
67	Sensor error HS1 Supply	B	Failure or short circuit on HS1 supply sensor
68	Sensor error HS2 Supply	B	Failure or short circuit on HS2 supply sensor
69	Sensor error HS3 Supply	B	Failure or short circuit on HS3 supply sensor
70	Sensor error HW1 Supply	B	Failure or short circuit on HW1 supply sensor
71	Sensor error HW2 Supply	B	Failure or short circuit on HW2 supply sensor
72	Sensor error HP1 Supply	B	Failure or short circuit on HP1 supply sensor
73	Sensor error HS1 Room	B	Failure or short circuit on HS1 room sensor
74	Sensor error HS2 Room	B	Failure or short circuit on HS2 room sensor
75	Sensor error HS3 Room	B	Failure or short circuit on HS3 room sensor
76	Sensor error HS1 Return	B	Failure or short circuit on HS1 return sensor
77	Sensor error HS2 Return	B	Failure or short circuit on HS2 return sensor
78	Sensor error HS3 Return	B	Failure or short circuit on HS3 return sensor
79	Sensor error HP1 Return	B	Failure or short circuit on HP1 return sensor
80	Sensor error Wind	B	Faulty signal from wind sensor
81	Sensor error Pressure	B	Faulty signal from pressure sensor
82	Sensor error Boiler temp	B	Failure or short circuit on boiler supply sensor
83	Sensor error Boiler return	B	Failure or short circuit on boiler return sensor
84	Sensor error CS1 Supply	B	Failure or short circuit on CS1 supply sensor
85	Sensor error CS1 Return	B	Failure or short circuit on CS1 return sensor
86	Sensor error HP Supply	B	Failure or short circuit on HP supply sensor

Configuration

	Alarm text	Prio	Description
87	Sensor error HP Return	B	Failure or short circuit on HP return sensor
88	Sensor error CP Supply	B	Failure or short circuit on CP supply sensor
89	Sensor error CP Return	B	Failure or short circuit on CP return sensor
90	Sensor error Extra sensor 1	B	Failure or short circuit on extra sensor 1
91	Sensor error Extra sensor 2	B	Failure or short circuit on extra sensor 2
92	Sensor error Extra sensor 3	B	Failure or short circuit on extra sensor 3
93	Sensor error Extra sensor 4	B	Failure or short circuit on extra sensor 4
94	Sensor error Extra sensor 5	B	Failure or short circuit on extra sensor 5
95	Sensor error Boiler supply	C	Failure or short circuit on boiler supply sensor
96	Sensor error Boiler1 Return	B	Failure or short circuit on boiler 1 return sensor
97	Sensor error Boiler2 Return	B	Failure or short circuit on boiler 2 return sensor
98	Sensor error Boiler3 Return	B	Failure or short circuit on boiler 3 return sensor
99	Sensor error Boiler4 Return	B	Failure or short circuit on boiler 4 return sensor
100	Sensor error 1 Extra Circuit	B	Failure or short circuit on additional control loop 1 sensor
101	Sensor error 2 Extra Circuit	B	Failure or short circuit on additional control loop 2 sensor
102	Sensor error CS1 room Ni1000	B	Failure or short circuit on CS1 room sensor
103	Sensor error CS1 Room 0-10V	B	Invalid value on CS1 room 0-10V
104	Sensor error HW1 Return	B	Failure or short circuit on HW1 return sensor
106	Deviation CS1	B	CS1 supply temperature deviates too much and too long from the setpoint
107	CS1 manual	B	CS1 in manual mode
108	CS1 Supply Max	B	CS1 maximum supply limit activated
109	CS1 Supply Min	B	CS1 minimum supply limit activated
110	CS1 Return Max	B	CS1 maximum return limit activated
111	CS1 Return Min	B	CS1 minimum return limit activated
112	Malfunction P1A-CS1	B	Malfunction on pump P1A-CS1
113	Malfunction P1B-CS1	B	Malfunction on pump P1B-CS1
114	Malfunction P1A&B-CS1	B	Malfunction on both circulation pumps P1A and P1B in CS1
115	P1A-CS1 manual	B	P1A-CS1 in manual mode
116	P1B-CS1 manual	B	P1B-CS1 in manual mode

	Alarm text	Prio	Description
117	Communication error Expansion unit 1	B	Communication interrupted between expansion unit 1 and master
118	Communication error Expansion unit 2	B	Communication interrupted between expansion unit 2 and master
119	Communication error M-bus DHM 1	B	Error on M-bus communication between master and district heating meter
120	Communication error M-bus WM 1	B	Error on M-bus communication between master and district heating meter 1
121	Communication error M-bus WM 2	B	Error on M-bus communication between master and district heating meter 2
122	Low return temp HW1	B	Return temperature too low for too long
123	Pressure/Flow error	B	Pressure or flow error in alarm circuit
124	Malfunction Boiler 1	B	Malfunction in boiler 1
125	Malfunction Boiler 2	B	Malfunction in boiler 2
126	Malfunction Boiler 3	B	Malfunction in boiler 3
127	Malfunction Boiler 4	B	Malfunction in boiler 4
128	Malf. Boilerpump 1	B	Malfunction in boiler pump 1
129	Malf. Boilerpump 2	B	Malfunction in boiler pump 2
130	Malf. Boilerpump 3	B	Malfunction in boiler pump 3
131	Malf. Boilerpump 4	B	Malfunction in boiler pump 4
132	Malf. transportpump	B	Malfunction in boiler transport pump
133	Boiler 1 manual	C	Boiler 1 in manual mode
134	Boiler 2 manual	C	Boiler 2 in manual mode
135	Boiler 3 manual	C	Boiler 3 in manual mode
136	Boiler 4 manual	C	Boiler 4 in manual mode
137	Boilerpump 1 Manual	C	Boiler pump 1 in manual mode
138	Boilerpump 2 Manual	C	Boiler pump 2 in manual mode
139	Boilerpump 3 Manual	C	Boiler pump 3 in manual mode
140	Boilerpump 4 Manual	C	Boiler pump 4 in manual mode
141	Transportpump Manual	C	Transport pump in manual mode
142	Malfunction P1-Ext.Circ.	B	Malfunction in P1 additional control loop
143	P1-Ext.Circ. manual	C	P1 additional control loop in manual mode
144	HW1 blocked for HS Priority	B	HW1 blocked due to HS priority
145	HW2 blocked for HS Priority	B	HW2 blocked due to HS priority

Configuration

	Alarm text	Prio	Description
146	HP1 blocked for HS Priority	B	HP1 blocked due to HS priority
147	HS1 blocked for HW Priority	B	HS1 blocked due to HW priority
148	HS2 blocked for HW Priority	B	HS2 blocked due to HW priority
149	HS3 blocked for HW Priority	B	HS3 blocked due to HW priority

9.16 Communication

9.16.1 Modbus communication

The flexotron800 can be connected to a network for Modbus communication. You do not need an activation code.

Interface 1 can be used either as a slave or as an expansion unit. If the interface is configured as a slave, the flexotron800 is set up to communicate via Modbus.

```
Function Port 1 →
Slave
```

Modbus is activated by pressing the [Right] button:

```
Modbus communication
Slave, Port 1
Not Active
```

If Modbus communication is activated, you can set the address and other parameters. To do this, press the [Right] button.

```
Modbus Address: 1
Speed: 9600 bps
Two stop bits: No
Parity: None
```



Only 1 stop bit can be used.

If the function is set to “Expansion unit”, it is possible to connect up to two expansion units. The expansion units must be assigned the addresses 241:1 and 241:2 respectively (ELA:PLA).

```
Expansion unit 1
None
Expansion unit 2
None
```

To commission the expansion units, select “Expansion unit” during the start-up. See also the SAUTER CASE flexotron manual. The hardware being used must be a flexotron800 V2.

After commissioning the expansion units and defining the master, you can configure all the inputs and outputs using the master under “Configuration > Inputs/Outputs”. The inputs and outputs of the expansion units are designated as “Exp1/Exp2”. For the connection see section 10.3.2.

```
flexotron800 vent
flexotron800 heat
Expansion unit 1
Expansion unit 2
```

9.16.2 BACnet communication

The flexotron800 V2 controller with TCP/IP interface can communicate via BACnet. The BACnet communication cannot be activated or changed via the display. This must be done using CASE flexotron. You must set the parameters “Device name”, “Device ID”, “BACnet UDP port” and “BBMD address”.

The flexotron800 is BTL-approved and fulfils the requirements for B-ASC (BACnet Application-Specific Controller).

The PICS document and the EDE files can be downloaded on the SAUTER website:
www.sauter-controls.com/de.

9.16.3 Dial-up modem

The flexotron800 can be connected to a higher-level system using a dial-up modem.

```
Modem: No
Number:
Password:
exo
```

9.16.4 Alarm forwarding via SMS

If a GSM modem is connected, the controller can send A-alarm messages to up to three recipients. You do not need an activation code to use this function. The alarm message consists of an alarm text, the name of the device (as shown in the first row of the start display) and the time when the alarm occurred. When there is an alarm, the message is sent to the first number on the list. If the recipient does not send an SMS within 5 minutes to confirm that the message has been received, the flexotron800 sends a message to the second number on the list.

```
SMS: Not active
No1:
No2:
No3:
```

9.17 Other parameters

These are various parameters which do not belong in any other menu.

```
General
HW1
HP1
```

9.17.1 General information

Building inertia and boost

For more detailed information see section 6.1.10.

The building inertia can be set between 0-24 h. 0 = current outside temperature, 24 = daily average.

Boost:

```
Shift = factor*(17-outside temp)* night reduction
```

The factor can be set from 0...10. 0 means no start delay and 10 is the maximum shift.

The running time in minutes for the shift is calculated as follows:

```
Running time = 1.6*(17 - outside temp)
```

 The running time is limited to a maximum of 60 minutes.

```
Building inertia
0 h
Boost factor (0-10)
0
```

Power limitation

The digital input signal “External power limitation” can be used to temporarily limit the power available to the heating circuits. When the input closes, the setpoint is lowered by an adjustable factor (in relation to 20 °C). The limitation affects all configured heating systems. The limitation is calculated as follows:

$$\text{Limited setpoint} = 20 + (\text{setpoint} - 20) * \text{factor} / 100$$

```
Power limitation
100% rel +20°C
```

Factor 100 means no setpoint reduction, 0 means complete reduction to 20 °C.

Frost-protection facility

If a controller is in Off or Manual mode and the outside temperature falls below a set value, an adjustable minimum supply temperature is maintained and the pump starts up.

```
Frost protect.:Off
Outdoor temp active.
Frost prot: 0.0°C
Min sup. temp: 10.0°C
```

Output signal splitting

Any of the output signals HS1, HS2, HS3, CS1, HW1 or HW2 can be split in two.

```
Split of any
temp sequence:
No split
```

Setting priority for HS or HW

The function can be set to HS or HW priority: If one of the circuits has priority and does not reach the setpoint within the delay time, the other circuits are forced to close. For more detailed information see sections 6.1.6 and 6.3.6.

```
Heat Prio: Off  
Temp diff.: 2°C  
Time before prio.:  
30 min
```

9.17.2 HW1**Anti-legionellae function**

This function periodically heats up HW1. It is used to prevent legionella bacteria from growing and spreading. This heating can take place once a day or once a week. The running time and the start time are adjustable. The function can be interrupted if the return temperature exceeds 62 °C. The shortest running time is 1 minute.

```
Periodical heating  
HW1:No Day:All  
Hour: 2 Setp.: 62°C  
Runtime: 1 min
```

9.17.3 HP1**Anti-legionellae function**

This function periodically heats up HP1. It is used to prevent legionella bacteria from growing and spreading. This heating can take place once a day or once a week. The starting time can be adjusted. The function can be interrupted if the return temperature exceeds 65 °C.

```
Periodical heating  
HP1:No  
Day:All Hour: 2  
Setp.: 65°C
```

9.18 System

9.18.1 Changing the language

Use this menu to change the display language.

```
Choose Language
English
```

You can also access this menu directly by pressing and holding the OK button when switching on, or by pressing the Right button three times when the start display appears.

9.18.2 Selecting the start display – text normally shown

There are five different start display texts to choose from:

Type 1

Line 2 shows the date and time.

Line 3 shows the text HS1.

Line 4 shows the current setpoint and the current temperature for HS1.

```
Heating controller
04:09:15 11:28
HS1
Sp:32.8°C Act:33.1°C
```

Type 2

Line 2 shows the date and time.

Line 3 shows the text HW1.

Line 4 shows the current setpoint and the current temperature for HW1.

```
Heating controller
04:09:15 11:28
HW1
Sp:55.0°C Act:54.8°C
```

Configuration

Type 3

Line 2 shows the text HS1/HW1.

Line 3 shows the current setpoint and the current temperature for HS1.

Line 4 shows the current setpoint and the current temperature for HW1.

```
Heating controller
HS1/HW1
Sp: 45.5°C Act: 43.8°C
Sp:55.0°C Act:54.8°C
```

Type 4

Line 2 shows the current temperature.

Line 3 shows the text HS1.

Line 4 shows the current setpoint and the current temperature for HS1.

```
Heating controller
Outd temp: 8.2°C
HS1
Sp:32.8°C Act:33.1°C
```

Type 5

Line 2 shows the date and time.

Line 3 shows the text CS1.

Line 4 shows the current setpoint and the current temperature for CS1.

```
Heating controller
04:09:15 11:28
CS1
Sp:13.0°C Act:12.5°C
```

9.18.3 Automatic summer/winter time change-over

If the automatic summer/winter time change is set, the system clock is automatically set to summer or winter time according to the European standard.

```
Automatic
summer
changeover
Yes
```

9.18.4 Controller bus address

The flexotron800 uses the bus addresses below to connect to CASE flexotron or when multiple controllers are part of a network. CASE flexotron normally uses the same bus addresses, so if an address is changed, the new address must also be entered in CASE flexotron. If several controllers are connected in a network, all the controllers must have the same PLA address, but each must have its own unique ELA address.

```
Address:
PLA: 254
ELA: 254
```

9.18.5 Remote operation using the display

If several controllers are connected in a network, it is possible to remotely control a device in the network using another device with a display. To do this, enter the address of the device you want to communicate with in the unit with the display. You can stop the connection by pressing the [Up], [OK] and [Down] buttons simultaneously.

```
Address for remote commu-
nication
(PLA:ELA) : 00:00
```

9.18.6 Automatic logout

If the access level is Operator, Service or Admin, the user is automatically logged out and returned to Basic level after a period of inactivity. The time can be set in increments of 5 seconds. Default: 60 units = 5 minutes

The automatic logout function can be disabled (see section 8.5).

```
Time before user
is automatically
logged off 60
(unit 5 s)
```

10 Settings

If you select one of the various controller systems, four submenus are displayed, with the exception of the extra control loop and HP, where only two submenus (“Actual/setpoint” and “Manual/auto”) are available.

The systems that you can then access depend on which inputs and outputs are configured.

For more detailed information on access rights and configuration, see sections 8 and 9.

```
HS1
HS2
HS3
CS1
HW1
HW2
Boiler
HP1
Extra circuit
Time / Extra timers
Holidays
Energy/Cold water
Running mode
Configuration
Access Rights
```

Submenus:

“Actual/setpoint”: For configuring the setpoints and gradient of the characteristics, and for reading the current temperature.

“Temperature control”: For setting the control parameters.

“Manual/auto”: For manually setting the pump and valves, or for reading the current signals.

“ECO/comfort”: For setting periods during which comfort heating and comfort cooling are required.

```
Actual/setpoint
Temp control
Manual/auto
HS1 ECO/comf mode
```

Settings

10.1 Actual/setpoint

10.1.1 HS1, HS2 and HS3

```
Outd temp: -5°C
HS1
Act: 49.8°C Setp. →
Setp.: 55.0°C
```

Submenu:

Here you can set the supply temperature for a particular outside temperature. You can set 8 schedule start points for each system.

The values in between must be calculated by linear interpolation. The supply temperatures at outside temperatures below the lowest schedule start point and above the highest schedule start point are calculated by linear extrapolation of the line between the last two start points at each end. Example: At the bottom end of the characteristic, the setpoint increases by 14 °C for every 5 °C decrease in the outside temperature. This means that the setpoint at an outside temperature of -23 °C is as follows: $77 + 3/5 * 14 = 85.4$ °C.

Only the values for the supply temperature can be changed on the flexotron800. The outside temperature values can be changed using CASE flexotron.

```
Outd comp setp HS1
-20°C = 67°C
-15°C = 63°C
-10°C = 59°C
```

```
Outd comp setp HS1
-5°C = 55°C
0°C = 53°C
5°C = 43°C
```

```
Outd comp setp HS1
10°C = 35°C
15°C = 25°C
Man paral dis 0°C
```

The heating systems have individual pump stop temperatures for day and night. If the outside temperature exceeds the set stop temperature, the circulation pump switches off and the signal at the valve actuator is set to 0. The pump starts up when the temperature falls below the set cut-off temperature by more than the set hysteresis. The heating circuit output can then be actuated when

there is a heat requirement. Night time is the time between 24:00 and 05:00 a.m. As well as the stop temperatures, you can also set start and stop delay times (see section 9.7).

```
Pump stop HS1:On
Stop temp day: 17°C
Stop temp night: 17°C
Hysteresis: 2.0°C
```

Submenu: Room-temperature sensor

Room temperature setpoint configuration. This menu is only available if the room-temperature sensor is configured.

```
Room sensor HS1
Actual: 20.8°C
Setpoint: 21.0°C
```

Submenu: Return temperature

```
Return temp
HS1: 28.0°C
```

10.1.2 CS1

The setpoint for the cooling system can be fixed or weather-dependent. The current valid setpoint is displayed in the first line. If dew point control is activated, the current setpoint is shifted if dew point control requires a higher setpoint.

With a constant setpoint:

```
CS1
Act: 13.0°C
Setp:13.0°C
```

With a weather-dependent setpoint:

```
Outd temp: 21.8°C
CS1
Act: 13.2°C Setp. →
Setp: 13.0°C
```

Settings

Press the Right button to go to set the supply temperatures for particular outside temperatures when a weather-dependent setpoint is selected. You can set 8 schedule start points.

```
Outd. comp.setp.CS1
20°C = 15°C
22°C = 14°C
24°C = 13°C
```

```
Outd. comp.setp.CS1
26°C = 12°C
28°C = 12°C
30°C = 11°C
```

```
Outd. comp.setp.CS1
32°C = 10°C
34°C = 9°C
Man paral dis 0°C
```

The values in between must be calculated by linear interpolation. The supply temperatures at outside temperatures below the lowest schedule start point and above the highest schedule start point are calculated by linear interpolation of the line between the last two start points at each end. Example: At the top end of the characteristic, the setpoint decreases by 1 °C for every 1°C increase in the outside temperature. This means that the setpoint at an outside temperature of 36 °C is as follows: $9 - 1 = 8$ °C.

The cooling system has individual pump stop temperatures for day and night. If the outside temperature falls below the set stop temperature, the circulation pump switches off and the signal at the valve actuator is set to 0. The pump starts up when the temperature rises above the set cut-off temperature by more than the set hysteresis. The heating circuit output can then be actuated when there is a cooling requirement. Night time is the time between 24:00 and 05:00 a.m. As well as the stop temperatures, you can also set start and stop delay times (see section 9.7).

```
Pump stop CS1:On
Stop temp day: 15°C
Stop temp night 15°C
Hysteresis: 2.0°C
```

Submenu: Room-temperature sensor

Either an Ni1000 or a 0...10 V transmitter can be used as the room temperature sensor for CS1. If you are using a temperature transmitter, its operating range must be 0...50 °C. The room temperature sensor does not directly affect temperature regulation, but can influence it when dew point control is activated.

```
Room sensor CS1  
Actual: 23.1°C
```

Submenu: Return temperature

```
Return temp  
CS1: 14.0°C
```

Submenu: Relative humidity

The humidity transmitter has an operating range corresponding to 0...100% relative humidity of the flexotron800.

```
Relative Humidity  
CS1: 43 %
```

10.1.3 HW1 and HW2

Actual value and setpoint for domestic hot water.

```
Supply temp. HW1  
Act: 53.0°C  
Setpoint: 55.0°C
```

Settings

10.1.4 HP1

```
Supply HP1
55.0°C
```

Submenu: Return temp

```
Return temp. HP1
45°C
```

Submenu: Start and stop temperatures for the pump

```
Loading HP1
Start temp: 46.0°C
Stop temp: 55.0°C
Temp diff: 2.0°C
```

10.1.5 Boiler

Different screen displays appear, depending on the type of setpoint selected for boiler control. For more detailed information see section 6.6.3.

Alternative 1 – constant setpoint:

```
HB Setpoint:
36°C
HB Actual:
36.5°C
```

Alternative 2 – control loop setpoint:

```
HS depending setp.
+ 5.0°C
HB Setpoint: 43.0°C
HB Actual: 43.2°C
```

Alternative 3 – weather-dependent setpoint:

```
Outd temp: 5°C  
HB  
Act.: 43.3°C Setp →  
Setp: 43.0°C
```

To set the weather-dependent characteristic, 8 points:

```
Out.comp.setp. HB  
-20°C = 67°C  
-15°C = 63°C  
-10°C = 59°C
```

```
Out.comp.setp. HB  
-5°C = 55°C  
0°C = 53°C  
5°C = 43°C
```

```
Out.comp.setp. HB  
10°C = 35°C  
15°C = 25°C  
Man paral dis 0°C
```

Return temperature for boilers 1, 2, 3 and 4

```
HB1 Return temp.:  
Setp: 40.0°C  
Actual: 39.7°C
```

If boiler control is set to OFF/ON, the cut-in and cut-out points for boilers 1...4 are set using the following menu display:

```
HB1 Temp: 33.5°C  
Start temp1: 5.0°C  
Start temp2: 5.0°C  
Stop temp: 3.0°C
```

Settings

For reading the shared return temperature sensor

```
HB Return temp.
43.0°C
```

10.1.6 Extra control loop

The actual value for the temperature sensor of the extra control loop as well as the pump start hysteresis. For the pump to start, extra temperature sensor 1 must be 5 °C higher than extra temperature sensor 2. The pump stops when extra temperature sensor 1 = extra temperature sensor 2. The hysteresis is freely configurable.

```
Temp1: 24.6°C
Temp2: 25.7°C
Start pump if
T1 > T2 + 5.0°C
```

10.2 Temperature control

10.2.1 General information

For regulation to function effectively, the controller parameters must be adjusted for the prevailing conditions. The lower the values for the P-band and I-time, the faster the controller reacts. However, it is important not to set the values too low, because otherwise the system may become unstable. On the other hand, the values must not be set too high, because then the temperature will fluctuate above and below the setpoint.

The P-band balances the control deviation proportionally. The I-time influences the controller output signals over time.

10.2.2 HS1, HS2 and HS3

Controller P-band and I-time settings.

```
HS1
P-band: 100.0°C
I-time: 100.0 s
```

Submenu: Only available for HS1 and HS2.

```
HS1 Return temp.  
P-band: 100.0°C  
I-time: 100.0 s
```

10.2.3 CS1

Controller P-band and I-time settings.

```
CS1  
P-band: 20.0°C  
I-time: 60.0 s
```

10.2.4 HW1 and HW2

```
HW1  
P-band: 25.0°C  
I-time: 75.0 s  
D-time 0.0 s
```

10.2.5 Boiler

Controller P-band and I-time settings.

```
Boiler  
P-band: 10.0°C  
I-time: 5.0 s
```

The time for which the controller is blocked after the burner starts or stops.

```
Time that the ctrl.  
is blocked at  
start/stop: 180 s  
Hysteresis: 0.5 %
```

Controller settings for return valves, boilers 1-4.

```
Boiler1 return temp  
P-band: 10.0°C
```

Settings

10.3 Manual/auto**10.3.1 General information**

This function is useful during commissioning and for troubleshooting.

All configured controller loops can be manually controlled between 0 and 100%. All configured pumps can be set to AUTO, ON or OFF.

A number of other functions can also be manually controlled.

 If an output is manually controlled, it means that normal regulation is disabled. For this reason, an alarm is generated whenever an output is set to an operating mode other than AUTO.

Because the menu display depends on the configuration, only the screens that most often appear are shown here. As well as AUTO, digital signals can normally be set to OFF or ON, which are the two possible states for digital signals.

10.3.2 HS1, HS2 and HS3

Manual operation / reading control signals for the actuators.

```
Manual/Auto
HS1
Auto
Manual set: 37
```

Submenu (for HS1 and HS2 only):

If the controller is set to return temperature, the output signal is delivered inversely to the actuator, i.e. 100% is 0 V at the analogue output.

```
Manual/Auto
HS1 Return temp.
Auto
Manual set: 37
```

Submenu (HS1 only):

If the controller is set to manual mode for external power limitation, the set maximum limit of the controller on the analogue output cannot be exceeded. The output signal will be between 0 V and the maximum limit.

```
Manual/Auto HS1
Power limit M-bus
Auto
Manual set: 55.0
```

Submenu: For manual operation or reading the pumps

```
Manual/Auto HS1
P1A: Auto
P1B: Auto
```

10.3.3 CS1

```
Manual/Auto
CS1
Auto
Manual set: 0.0
```

Submenu: For manual operation of the pump

```
Manual/Auto CS1
P1A:Auto
P1B:Auto
```

Submenu: For manual operation of the digital output CS1, start cooling unit

```
Manual/Auto
Cooling Unit:
Auto
```

10.3.4 HW1 and HW2

```
Manual/Auto
HW1
Auto
Manual set: 37.0
```

Settings

Submenu: For manual operation of the pump (HW1 only)

```
Manual/Auto
P1-HW1:Auto
```

10.3.5 HP1

```
Manual/Auto
HP1:Auto
```

10.3.6 Boiler

Menu for setting the burners, circulation pumps, return valves and transport pumps to manual mode. The menu structure depends on the configuration.

Alternative 1 - OFF/ON:

Boilers 1...4 can be set to AUTO/Manual OFF/Start1/Start2 with 2-step burners and AUTO/Manual OFF/Manual ON with 1-step burners.

```
Manual/Auto
Boiler 1: Auto
```

Alternative 2 - OFF/ON/modulating control:

If a modulating burner has been selected for boiler 1:

```
Manual/Auto
Modulating boiler
Auto
Manual set: 2 %
```



This not only affects the modulating burner, but the controller as a whole. The controller signal is distributed equally among the number of burners. If you only want to set the modulating burner to manual mode, you must first calculate the proportion of the controller signal which is modulating, i.e. $100\%/X$ = the percentage that must be set on the controller to reach 10 V at the analogue output, where X is the total number of burners including the modulating burner.

The 1- and 2-step burners can be set to AUTO/Manual OFF/Start1/Start2 with 2-step burners and AUTO/Manual OFF/Manual ON with 1-step burners.

```
Manual/Auto
Boiler 2: Auto
```

Alternative 3 - modulating control:

Only the controller can be put into manual mode here. This means that not only the burners that start up second, third and fourth can be put into manual mode, but the burners that start up at a lower percentage also start. This problem can be avoided either by changing the burner starting sequence, i.e. the burner to be set to manual mode must be set as the fixed first boiler "Fixed 1st". Alternatively, you can set the output to manual mode using the configuration menu.

```
Manual/Auto
Modulating boiler
Auto
Manual set: 56 %
```

The AUTO/Manual OFF/Manual ON setting is for manual operation of boiler pumps 1...4.

```
Manual/Auto
Boiler pump 1:
Auto
```

The AUTO/Manual OFF/Manual ON setting is for manual operation of the transport pump.

```
Manual/Auto
Transport pump:
Auto
```

The AUTO/Manual OFF/Manual ON setting is for manual operation of return valves 1...4.

```
Manual/Auto
HB1 Return Temp
Auto
Manual set: 0.0
```

Settings

10.3.7 Extra control loop

For manual operation of the pump in the extra control loop.

```
Manual/Auto
Ext pump: Auto
```

10.4 ECO/comfort function

10.4.1 General information

Two comfort temperature periods can be set for every day. When the heating system is outside its comfort periods, it is put into ECO (economy) mode. The setpoint is then reduced by 5 degrees in the room (adjustable). One degree in the room corresponds to a reduction of the supply temperature setpoint by three degrees. When the cooling system is outside its comfort periods, the supply setpoint is increased by an adjustable number of degrees.

The comfort function is not active on delivery. It must be activated for each of the various systems when an increase or decrease in ECO mode is required.

10.4.2 HS1, HS2, HS3, HW1, HW2 and CS1

```
HS1 ECO/comf mode
On →
5°C (room degrees)
```

Submenu: Setting the comfort periods.

Each controller system has 8 separate setting menus – one for every day of the week and an additional one for the holiday programme. The holiday programme has priority over the other programmes.

For all-day operation, set a period of 00:00 – 24:00.

To deactivate a period, set it to 00:00 – 00:00.

```
HS1 Comfort time
Monday
Per 1: 07:00 – 16:00
Per 2: 00:00 – 00:00
```

```
HS1 Comfort time
Tuesday
Per 1: 07:00 – 16:00
Per 2: 00:00 – 00:00
```

```
HS1 Comfort time
Wednesday
Per 1: 07:00 - 16:00
Per 2: 00:00 - 00:00
```

```
HS1 Comfort time
Thursday
Per 1: 07:00 - 16:00
Per 2: 00:00 - 00:00
```

```
HS1 Comfort time
Friday
Per 1: 07:00 - 16:00
Per 2: 00:00 - 00:00
```

```
HS1 Comfort time
Saturday
Per 1: 00:00 - 00:00
Per 2: 00:00 - 00:00
```

```
HS1 Comfort time
Sunday
Per 1: 00:00 - 00:00
Per 2: 00:00 - 00:00
```

```
HS1 Comfort time
Holidays
Per 1: 00:00 - 00:00
Per 2: 00:00 - 00:00
```

Here you set how long the circuit is to remain in the comfort mode after the digital input is closed. "Time in extended operation" is used to display how long the circuit was in comfort mode. This can also be changed manually. If "Time in extended operation = extended operation" is set, the circuit can be reset to the ECO mode.

```
Extended running
0 min
Time in ext running
0 min
```

Settings

10.5 Time/Timer outputs
10.5.1 General information

The flexotron800 has a year-round clock function with automatic winter/summer time change. To see timer outputs 1...5 in the display, they must first be configured.

```
Time/Date
Timer output 1
Timer output 2
Timer output 3
Timer output 4
Timer output 5
```

10.5.2 Time/Date

Using this menu you can see and change the time and date. The time is shown in the 24-hour format. The date has the format YY-MM-DD.

```
Time: 18:21
Date: 10:01:01
Weekday: Wednesday
```

10.5.3 Timer outputs

Up to five separate digital timer outputs can be configured. Each has a weekly programme with two activation periods per day. Each timer output has eight separate setting menus – one for every day of the week and an additional one for the holiday programme. The holiday programme has priority over the other programmes.

```
Timer output 1
Monday
Per 1: 07:00 - 16:00
Per 2: 00:00 - 00:00
```

10.6 Holiday

Up to 24 separate holiday periods can be configured for a whole year in advance.

A holiday period can consist of any number of days, from 1...365 consecutive days. The date always has the format: MM:DD

If the current date is within a holiday period, the operating programme for holidays is used.

```
Holidays (mm:dd)
1: 01:01 - 02:01
2: 09:04 - 12:04
3: 01:05 - 01:05
```

10.7 Energy/Cold water

This menu displays the readings from the pulse meter inputs. The pulse constants (pulses per unit) are defined in the "Configuration > Pulse constants" menu.

```
Heating meter
Cold water meter 1
Cold water meter 2
Electricity meter
Leakage monitoring
```

10.7.1 Heating meter

```
Energy total
1532.3 MWh
Hot water total
387.02 m3
```

The values below can be reset.

```
Energy
Today: 28.15 kWh
Yesterday: 123.45 kWh
D B Y-day: 132.11 kWh
```

```
Consumption
Today: 28.15 lit
Yesterday: 123.45 lit
D B Y-day: 132.11 lit
```

Settings

```
Power consumption
Instant: 2100.0
Average/h: 3200.0
Max aver: 5300.0
```

10.7.2 Cold water meters for CW1 and CW2

```
CW1 consum total
276.22 m3
CW1 Flow
156.4 l/min
```

```
CW1 consump
Today: 88.1 l
Yesterday: 4123.4 l
D B Y-day: 5012.1 l
```

```
Lowest CW1 consump
Today: 0.1 l/h
Yesterday: 0.2 l/h
```

10.7.3 Electricity meter

```
Energy total
1866.54 MWh
```

This value can be reset.

10.7.4 Leakage monitoring

```
Leakage monitoring
1.31 kW
```

10.8 Running mode

You cannot make changes in the Running mode menu. It is simply for viewing the current values and alarm log.

```
Alarms
Inputs/Outputs
Extra Sensors
```

10.8.1 Alarms

The alarm log of the flexotron800 contains the 40 most recent alarms. The latest event is at the top of the list. The alarm log is solely for viewing alarms in order to assist troubleshooting.

```
14 Jul 18:57 B
Sensor error CS Return

Activated
```

```
14 Jul 19:05 B
Sensor error CS Return

Acknowledged
```

```
14 Jul 19:10 B
Sensor error CS Return

Switches off
```

10.8.2 Inputs/Outputs

The “Inputs/Outputs” menu displays the raw values from the sensors, the signals at the analogue outputs and the current status of the digital inputs and outputs.

```
AI
DI
UI
AO
DO
```

Settings

```
AI1: -3.5 Outd temp  
AI2: 53.7 HS1 Supply  
AI3: 54.8 HW1 Supply  
AI4: 50.6 HS1 Return
```

```
DO1: On HS1-PumpA  
DO2: Off HS1-PumpB  
DO3: Off Inc HS1-Act.  
DO4: On Dec HS1-Act.  
DO5: On HW1-Pump  
DO6: On HS2-PumpA  
DO7: On Sum alarm
```

10.8.3 Extra sensors

Up to five extra temperature sensors can be connected. They are only used to display the temperature. You can give the sensors any name you want. To do this, press the [OK] button and then use the [Up] and [Down] buttons.

```
Extra Sensor1  
Act: 51.2°C
```

11 Expansion units

 Expansion units can only be used if a flexotron800 with a serial interface is used as the master.

For a list of the various flexotron800 models, see the summary in section 3.4.

11.1 RS485 interfaces

The interfaces can be set either as a slave or as an expansion unit/external sensor.

If the interface is configured as a slave, the flexotron800 can be connected with a higher-level system, or alternatively with CASE flexotron.

If the interface is configured as an expansion unit/external sensor, one or two expansion units can be connected to the interface. The expansion units must be controllers of type flexotron800 V2.

It is possible to use a flexotron800 with display as an expansion unit. However, this is of no practical use, as the display of an expansion unit cannot be used and cannot display information.

The first time a slave unit without a display is started up, an external display is required to activate the controller as an expansion unit. If you are initialising it using CASE flexotron, no external display is required.

The configuration is performed either using CASE flexotron or the display on the master unit. The master unit displays all the inputs and outputs.

11.2 Connection

11.2.1 Expansion units

The master unit and expansion units communicate using a proprietary bus. The slave controllers are initialised with the address 241:1 or 241:2 (PLA:ELA).

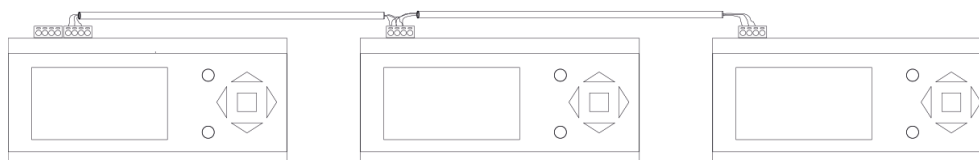

12 Other functions

12.1 Alarm handling

If an alarm occurs, the red alarm LED flashes, either on the front of the display units or on an external display. The LED flashes until all the alarms have been acknowledged.

Alarms are logged in the alarm list. The list shows the type of alarm, the date and the time, and the alarm class (A, B or C).

Press the [Alarm] button on the front panel to see the alarm list.

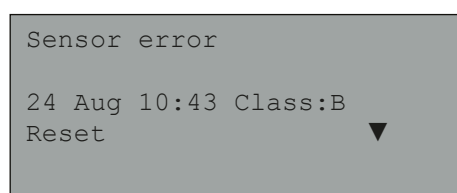

```
Sensor error
24 Aug 10:43 Class:B
Reset ▼
```

If several alarms are active, two arrows ([Up]/[Down]) appear on the right of the display.

Use the [Up] and [Down] buttons to scroll to the other alarms.

The alarm status is shown in the bottom left of the display. For active, unacknowledged alarms this field is blank. Cancelled indicates alarms that have been interrupted. Acknowledged alarms or alarms that are blocked but still active are indicated as acknowledged or blocked.

To acknowledge an alarm, press the [OK] button. You can then either acknowledge or block the alarm.

Acknowledged alarms remain on the alarm list until the cause of the alarm has been eliminated. The LED remains lit.

Blocked alarms remain on the alarm list until the cause of the alarm has been eliminated and the block has been removed. New alarms of the same type will not be activated until the block has been removed.



Because blocking alarms can be potentially hazardous, you need a high user access level to do this.

Class A and B alarms activate alarm outputs if these have been configured.

Class C alarms do not activate the alarm outputs.



Class C alarms are removed from the alarm list when the alarm inputs are reset, even if they are not acknowledged.

Other functions

Alarm log

The flexotron800 also has an alarm log containing the 40 most recent alarms. For more detailed information see section 10.8.1.

12.2 Status indicators

Information	Colour	Description
P1 RxTx	Yellow/green	Interface 1, send/receive
P2 RxTx	Yellow/green	Interface 2, send/receive
TCP/IP (TCP models)	Yellow/green	Green: Connection to other network devices Flashing green: Network data transfer Flashing yellow: For identification
P/B (power supply / battery)	Green/red	Power supply on / battery fault
Controller with built-in display:	-	-
	Red	Alarm display
	Yellow	Input mode

12.3 Changing the battery

-  To carry out this measure, you absolutely must have sound knowledge of electrostatic discharges and protective measures (you must use an earthed wrist strap)!

If the “internal battery” alarm was triggered and the battery LED lights up red, the battery is too weak (for holding the application memory content and the Real Time Clock) and must be replaced. The battery is replaced as described in the following. A back-up capacitor protects the content of the memory and the Real Time Clock for at least 10 minutes without power. Therefore, if it takes less than 10 minutes to change the battery, it will not be necessary to reload the program or reset the clock.

-  The new battery must be a CR2032 battery.

The cover is removed by using a small screwdriver to carefully push in the little hooks on the edge of the cover and simultaneously push the edge of the cover outwards.



Position of the battery

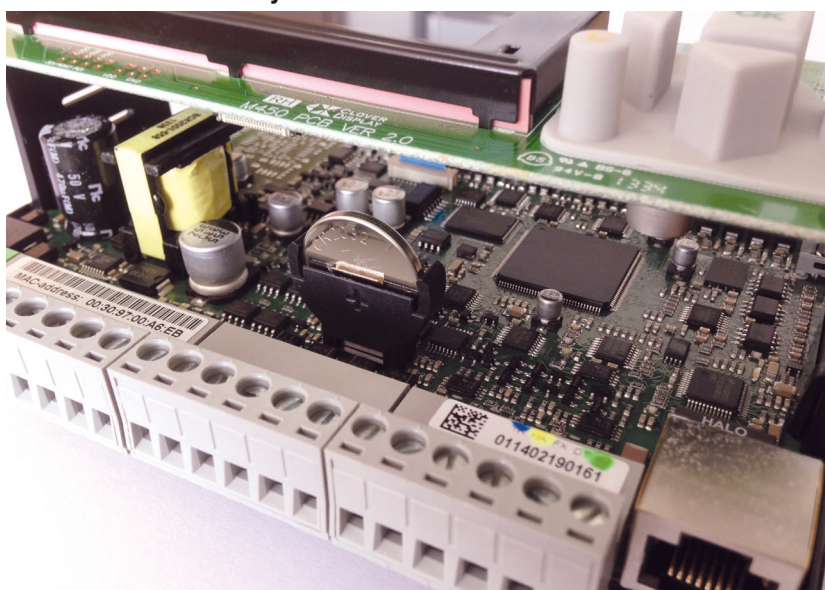

Grip the battery firmly with your fingers and pull it upwards until it is released from the holder.

Firmly push the new battery into the holder. For correct operation, make sure you observe the polarity.

Other functions

12.4 Individual text field

If you press the [Right] button once in the start menu, a display appears with a text of your own choice. You can use the text for the name of the installing company, for service contacts and telephone numbers or other information. The simplest way to enter the text is with CASE flexotron, but you can also use the buttons. Four lines of 20 characters are available.

12.5 Version number

If you press the [Right] button twice in the start menu, the version number of the program and the ID number appear in the display.

© Fr. Sauter AG
Im Surinam 55
CH-4016 Basel
Tel. +41 61 - 695 55 55
Fax +41 61 - 695 55 10
www.sauter-controls.com
info@sauter-controls.com