

EY-RU 365: Touch room operating unit, ecoUnit365

How energy efficiency is improved

Intuitive, local operation of room automation for optimum room climate, light and sunshade. The touchscreen shows users the correct room information at any time from the various application areas.

Features

- Part of the SAUTER EY-modulo 5 system family
- High quality room operating unit with touch operation and tile display
- 3.5" TFT colour display, 320x240 pixels
- Scratch-resistant, capacitive touch interface
- Navigation of up to 6 pages with up to 6 functions (tiles) each
- Intuitive operation for 4 predefined functions (temperature, lights, blinds and fans)
- Up to 12 setpoints can be defined as a reference for BACnet objects
- Display of the energy efficiency function ("ECO 10")
- Mode and symbol displays, e.g. heating/cooling
- Audio feedback when pressed
- 24 V~/= power supply
- SLC/RS-485 communicative interface for ecos 5
- Can be located up to 500 m from the automation station
- 6 digital inputs for connecting presence detector, door/window contacts, digital contact directly
- Configuration with CASE Suite (CASE Engine "EY-RU365 module configuration", RU_TOUCH module)
- Optional: Bluetooth 4.0 LE for using a BT app on a smartphone



EY-RU365F001

Technical data

Power supply

Power supply	24 V~/=, ±20% – SELV 0 / 50/60 Hz or from EY-PS021 of the ecos
Power consumption during operation	< 2.6 W

Ambient conditions

Operation	Operating temperature	0...45 °C
	Admissible ambient humidity	10...85% rh, no condensation
Transport	Admissible ambient humidity	< 85% rh, no condensation
	Storage and transport temperature	-25...70 °C

Parameters

Temperature sensors	Setpoint	Up to 12 setpoint entries, configurable
	Symbol	Up to 6 symbols: room mode - comfort/reduced/set-back; ECO mode – green-yellow-red; heating/cooling; windows; humidity; wind; alarm; block
	Number of functions	Up to 6 pages Up to 6 tiles per page
	Tile function	Temperature, fan, light dimming, light switching, control of window blinds (position/angle)
	Special functions	°C/°F changeover for temperature function; Home button; Navigation display; (Title) labelling for pages, tiles and functions
	Screensaver display	None, Time or Actual Temperature
	Type of sensor	NTC 10kOhm
	Measuring range	0...40 °C
	Resolution	0.1 K
	Updating interval	1 s
Drift	< 0.1 °C/year	
Position	Bottom left	



Inputs	Number of inputs	6
	Type of inputs	For potential-free switching contacts
	Polling voltage	24 V= unregulated
	Polling current	>3 mA (closed contact)
	Internal resistance	> 4.7 kOhm
	Refresh interval input	20 ms
	Switching thresholds	<10 V (voltage "rising") > 6 V (voltage "falling")
	Switching hysteresis	>1 V
Audible feedback	Type	Piezoelectric signal
	Application	Audio feedback when touch function is executed
Display with backlight	Screen diagonal	3.5 inches (8.9 cm)
	Resolution	320 x 240 pixels
	Refresh interval display	60 Hz
	Type	TFT
	Number of colours	262,000
	Brightness	500 cd/m ²
	Contrast ratio	300
	Perspective	From above:15° From below:35° From left/right:45°
Touchpad	Touchpad type	Capacitive with gesture recognition
	Refresh rate	10 ms
Light sensor	Type of sensor	Phototransistor with integrated filter
	Measuring range	0...5000 lux
	Resolution	Typ.10 lux
	Position sensor	In the middle above the display
	Refresh rate	100 ms
Interfaces and communication		
Connection terminals	SLC/RS-485, DI, power supply	2 x 6-pin screw terminals, pluggable, for solid or braided wires, max. 1.5 mm ² (grid dimension 5 mm)
Communication	Activation	From ecos 5
	Interface	RS-485 with 115kbit/s (no integrated terminating resistor)
	Protocol	SLC (SAUTER Local Communication)
	Line	2-wire twisted, shielded (D+, D-); MM terminal is reference for RS-485; shielded at controller
	Cable length	≤ 500 m with bus termination
	Protection circuit	Protected against excess voltage and reversed polarity
	Wireless	Bluetooth specification
Module		Panasonic PAN1740
Number of app participants		1 simultaneously 256 registered
Supported OS Bluetooth app		iOS 8.0 or higher Android 4.1 (Jelly Bean) or higher
Construction		
Device dimensions	Fitting	Recessed mounting
	Dimensions W x H	Glass front:86 x 86 mm ² Plastic housing:85 x 85 mm ²
	Surface depth T	Max. 15 mm
	Recessed depth T (recessed junction box)	Min. 34 mm (incl. terminals)
	Compatible recessed junction boxes	Swiss and European recessed junction boxes

Housing	Colour	F0*1:White (similar to RAL 9010) F0*2:Black (similar to RAL 9005)
Weight	Weight	F0*1:0.190 kg F0*2:0.200 kg
Glass front	Glass type	Float glass, chemically hardened soda-lime glass
	Glass thickness	2.9 mm
	Surface hardness	6 H

Standards and directives

	Software class	A (EN60730)
	Plastic fire classification	UL94V2
	Type of protection	IP30 (EN 60529)
	Protection class	III (EN 60730)
	Environment class	3K3 (IEC 60721)
CE conformity according to	EMC Directive 2014/30/EU	EN 50491-5-2, EN 50491-5-3
	Wireless (Bluetooth)	ETSI EN 300 328 v1.8.1
	RED Directive as per 2014/53/EU	ETSI EN 301 489-1 v1.9.2 ETSI EN 301 489-17 v2.1.1
EU regulation	RoHS Directive 2011/65/EU	EN 50581
	Reach conformity	1907/2006
	WEEE	2012/19/EU

Overview of types

Type	Title
EY-RU365F001	ecoUnit365, white, touch, NTC, 6DI
EY-RU365F002	ecoUnit365, white, touch, NTC, 6DI, Bluetooth
EY-RU365F0A1	ecoUnit365, black, touch, NTC, 6DI
EY-RU365F0A2	ecoUnit365, black, touch, NTC, 6DI, Bluetooth

Accessories

Type	Description
EY-PS021F***	Power supply EY-PS 021

Intended use

This product is only suitable for the purpose intended by the manufacturer, as described in the "Description of operation" section.

All related product regulations must also be adhered to. Changing or converting the product is not admissible.

Description of operation

The ecoUnit365 (EY-RU 365) touch room operating unit with its scratch-resistant touch surface records the room temperature. It is used for the local operation of up to 12 setpoints for temperature control, fan control, lighting and sunshade for one or more rooms. The "virtual" buttons in the touch display are defined as function tiles. The functions defined on up to six pages, with up to six tiles per page, can be operated intuitively using the gesture control familiar from smartphone usage. The functions and the pages can be assigned names and titles in text form. The pre-defined symbols for functions (e.g. temperature meter, fan, window blind, lamp) make the local operation of the room automation easy and clear.

The room operating unit belongs to the ecos 5 product family and can be connected to a room automation station (RC) of the EY-modulo 5 system family using the digital RS-485 connection. The touch display can be controlled using the station. The station's user program can control the different symbols of the status indicator according to the automation plan.

The room operating unit also has 6 digital inputs that can be used for potential-free contacts (e.g. presence detectors, light switches).

The touch room operating unit with a Bluetooth interface (EY-RU 365F0*2) enables the user to control the functions of the ecoUnit365 using a smartphone and the "SAUTER room management" app (iOS, Android) via Bluetooth 4.0 LE.

Main view, screensaver, sub-pages

The main screen of the device can be structured differently depending on the parameterisation. You can use the CASE Engine module configuration to make any adjustments that you want. You can define up to 6 pages with up to 6 tiles and functions. One of the pages is used as the main view. The

parameterisation can also activate a screensaver that displays the current time or the room temperature of the integrated room sensor. When you use a function tile you modify the setpoints on the lower-level page, e.g. illuminance, window blind position/angle, fan speed. You can use the “slider” to define the setpoint for the automation. The function tile can also be defined to switch lights directly (ON/OFF).

Type

EY-RU 365
main view

Examples of possible views

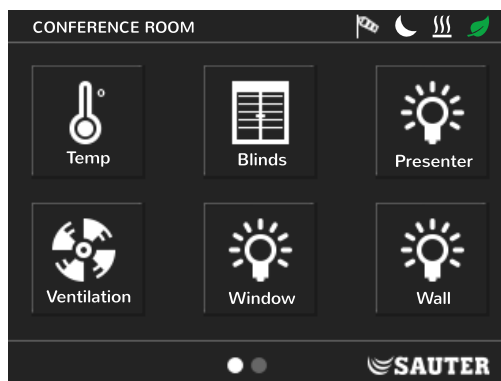

EY-RU 365
setpoint
(sub-page)

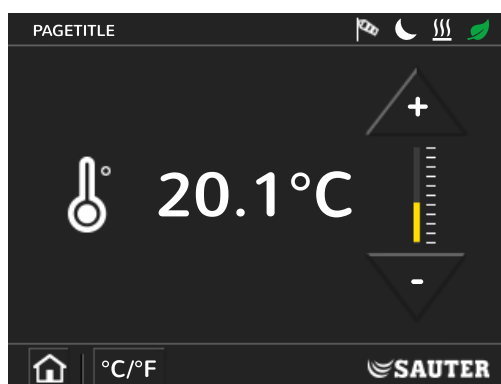

Engineering notes

Fitting

The ecoUnit365 touch room operating unit (EY-RU 365) is suitable for recessed mounting (recessed junction box 55 mm x 55 mm). Its dimensions are the standard 86 mm x 86 mm and it has a scratch-resistant touch glass surface in black or white.

The room operating unit also has 6 digital inputs which can be used to connect light switches and buttons, presence contacts or other potential-free contacts directly to the device and use them in the automation station's application program.

The device is delivered in two parts – the “basic unit” module with power supply unit, terminals for the supply voltage, RS-485 and digital inputs, and the “touch operating unit” with microprocessor, Bluetooth, sensors, display, beeper and display brightness control. Only the basic unit is used for the fitting and wiring. Thus, the touch operating unit may only be mounted, as per the fitting instructions, during the “clean” commissioning (e.g. after the painter and carpenter have finished their work).

Connection, power supply and communication with the automation station

The room operating unit requires a 24 V power supply. This should be the same as the power supply used, for example, for the ecos504/505. A stable 24V power supply increases the stability of the temperature measuring accuracy.

If the room operating units and the ecos controller have different power supplies, the power supply references (MM) must have the same potential (connect the MM terminal of the controller and the MM terminal of the room operating units).

A voltage drop over the supply cable must not be below the power supply thresholds (24V - 20%); thus, 1.5 mm² NYM cables should be used, for example.

For the data communication with the station, the room operating unit is connected to this station with a shielded cable with twisted-pair wiring with at least 2 wires. It is recommended to use a 2 x 2-wire, twisted-pair, shielded cable; the unused wire pair can be kept as a reserve or used as required. The maximum admissible bus length depends on the cable type used and the correct termination with terminating resistors. Observe the correct polarity (D+/D-). The cable shield of the entire bus line must

be connected continuously, and connected to the protective earth as directly as possible (max. 8 cm) at one location, preferably close to the ecos controller, in order to achieve optimum resistance to interference. For Ethernet CAT-5 cables, as well as IYST-Y cables, a bus length of up to 500 m is possible, both for applications in residential, business and commercial areas and for applications in the industrial sector.

In the case of RS-485 interfaces, the bus wiring must follow line topology. Star, tree or branch topologies are not recommended. The devices do not have internal terminating resistors. A terminating resistor of 120 Ω (0.25 W) must be connected at the start and end of the bus line, parallel to the D+/D- data lines. The MM terminal of the EY-RU365 room operating unit is also a reference for its RS-485, but it must not be connected to the RS-485/C terminal of the ecos. If there are other bus subscribers (e.g. ecoLink, ecoUnit31*/34*, ecoMod580), the RS-485 reference (C) must bypass the EY-RU 365. Only connect the C and +5 V terminals on the ecos if the bus subscribers require this; see also the fitting instructions of all bus subscribers.

Addressing the operating units

A device address must be set on the communicative room operating units to ensure that they can be contacted by the automation station. This address must match the station's user program. The address is 1...4 (1 as delivered ex works). The addressing mode can be called up by pressing and holding down (for at least 5 seconds) the touch area at the bottom left where the SAUTER logo is usually displayed. When you select tiles 1 to 4 and leave the addressing mode using the "home button" at the bottom left, the corresponding address is set for the touch room operating unit.

ECO symbol

The ECO symbol (sheet with different colours: green, red, yellow, white) is used to visualise the energy efficiency of the controlled room via the user program of the automation station. This function is used to indicate optimal energy consumption in the room via the colour green. The colour red indicates that the energy consumption is too high.

Parameterising ecoUnit-Touch with CASE Suite

With CASE Engine and the configuration of the "ecoUnit-Touch" module, you parameterise the operating device with the functions that you want. You can define the general device parameters, up to 12 setpoint data channels and functions for the individual pages and tiles. The functions for lighting, window blinds, temperature and fan can be assigned to operating elements such as slider, switch and double-slider. You can check the configuration using the integrated device simulator. Further information on the module configuration of the ecoUnit-Touch can be found in the "CASE Engine" documentation.

Connecting the ecoUnit-Touch to the user program of the automation station

How the automation station or the operating unit and display respond to the press of a button is defined in the user program. The "RU_TOUCH" module is available in the firmware for this purpose. This module is described in the "Firmware modules" documentation.

Setpoints and resetting setpoints

The 12 setpoints of the ecoUnit-Touch are queried by the station as SLC data channels (D01..D12). These setpoints are read in with a BACnet Input/Value Object as a reference (data source) and can thus be used in the plan.

Display functions

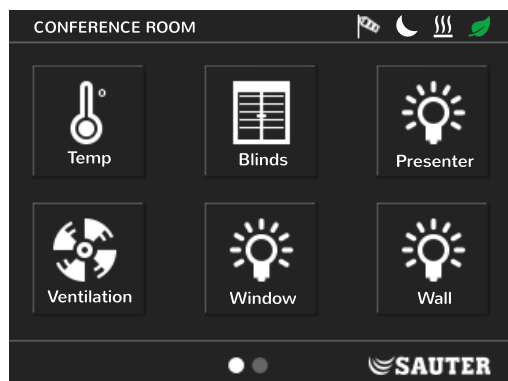

Status line with symbols (above):

- ECO 10 display as sheet (green, red, yellow)
- Symbols: Wind warning, block symbol, room mode (present, absent, night), heating/cooling symbol
- Menu text for function or location

Screen with up to 6 tile functions:

Four functions:

- Light (dimming or only switching)
- Sunshade (2 setpoints)
- Ventilation (analogue setpoint, e.g. 0...3)
- Temperature (analogue setpoint, e.g. 19..24°C)

Status line (below):

- Home button
- Unit switching with temperature function (°C/°F)
- Orientation points for page navigation (up to 6)
- Logo (for addressing)

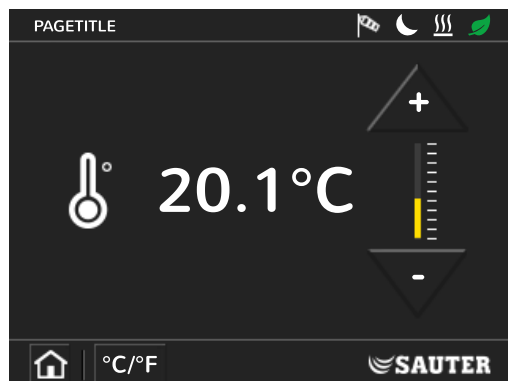

Update of the device software (firmware update)

The device is delivered with application software. The boot loader function allows you to update the application software of the device in the field. The device is automatically updated with the selected version via a CASE Engine download.

Additional information

Fitting instructions	P100001966
Declaration on materials and the environment	MD 94.042
Dimension drawing	M10501
Connection diagram	A10523

Disposal

When disposing of the product, observe the currently applicable local laws.
 More information on materials can be found in the Declaration on materials and the environment for this product.

EY-RU 365 connection diagram

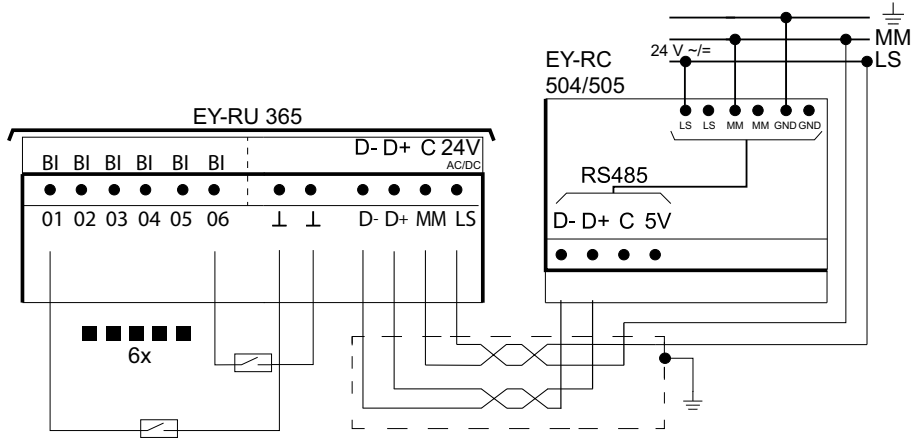

Power supply +24 V	LS
Supply reference, RS-485	MM
SLC/RS-485 D+	D+
SLC/RS-485 D-	D-
Reference for digital inputs	⊥
Reference for digital inputs	⊥
Digital input 1...6	BI 01...BI 06

Supply, communication

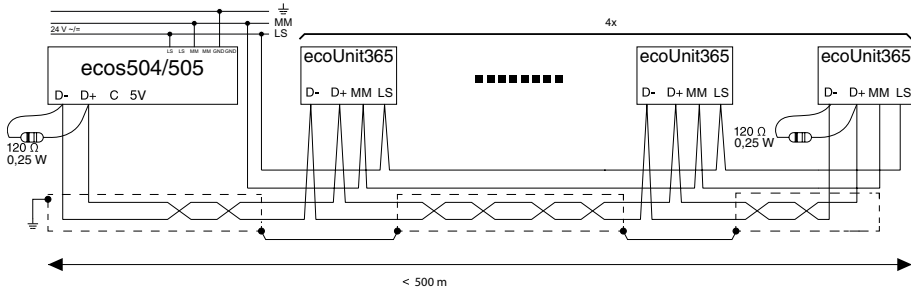

Supply, communication with other bus participants

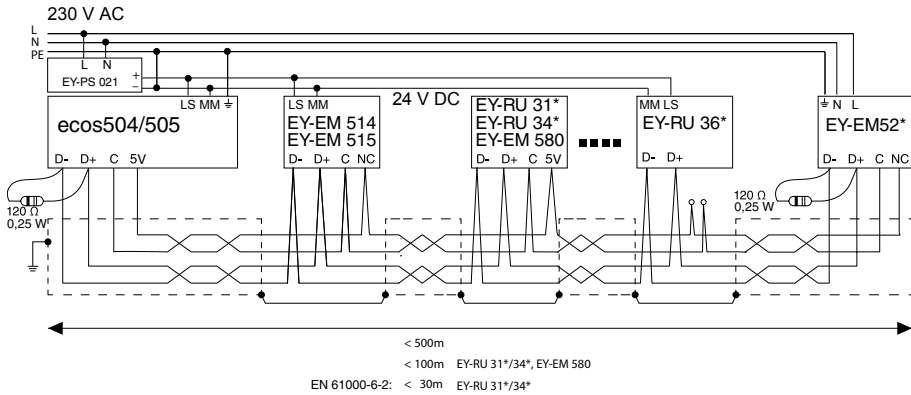

Dimension drawing

